

Multi-touch series LCD
55, 65, 75, 84 inch



www.philips.com/welcome

User Manual (English)

PHILIPS

SignageSolutions

Safety Instructions

Safety precautions and maintenance



WARNING: Use of controls, adjustments or procedures other than those specified in this documentation may result in exposure to shock, electrical hazards and/or mechanical hazards.

Read and follow these instructions when connecting and using your display:

Operation:

- Keep the display out of direct sunlight and away from stoves or any other heat sources.
- Remove any object that could fall into ventilation holes or prevent proper cooling of the display's electronics.
- Do not block the ventilation holes on the cabinet.
- When positioning the display, make sure the power plug and outlet are easily accessible.
- When turning off the display by detaching the power cord, wait 6 seconds before re-attaching the power cord for normal operation.
- Ensure the use of an approved power cord provided by Philips at all times. If your power cord is missing, please contact your local service center.
- Do not subject the display to severe vibration or high impact conditions during operation.
- Do not knock or drop the display during operation or transportation.

Maintenance:

- To protect your display from possible damage, do not put excessive pressure on the LCD panel. When moving your display, grasp the frame to lift; do not lift the display by placing your hand or fingers on the LCD panel.
- Unplug the display if you are not going to use it for an extensive period of time.
- Unplug the display if you need to clean it with a slightly damp cloth. The screen may be wiped with a dry cloth when the power is off. However, never use organic solvent, such as, alcohol, or ammonia-based liquids to clean your display.
- To avoid the risk of shock or permanent damage to the set, do not expose the display to dust, rain, water or an excessively moist environment.
- If your display becomes wet, wipe it with dry cloth as soon as possible.
- If a foreign substance or water gets in your display, turn the power off immediately and disconnect the power cord. Then remove the foreign substance or water, and send the unit to the maintenance center.
- Do not store or use the display in locations exposed to heat, direct sunlight or extreme cold.
- In order to maintain the best performance of your display and ensure a longer lifetime, we strongly recommend using the display in a location that falls within the following temperature and humidity ranges.
 - Temperature: 0-40°C 32-104°F
 - Humidity: 20-80% RH

IMPORTANT: Always activate a moving screen saver program when you leave your display unattended. Always activate a periodic screen refresh application if the unit will display unchanging static content. Uninterrupted display of still or static images over an extended period may cause "burn in", also known as "after-imaging" or "ghost imaging", on your screen. This is a well-known phenomenon in LCD panel technology. In most cases, the "burned in" or "after-imaging" or "ghost imaging" will disappear gradually over a period of time after the power has been switched off.

WARNING: Severe "burn-in" or "after-image" or "ghost image" symptoms will not disappear and cannot be repaired. This is also not covered under the terms of your warranty.

Service:

- The casing cover should be opened only by qualified service personnel.
- If there is any need for repair or integration, please contact your local service center.
- Do not leave your display under direct sunlight.



If your display does not operate normally, having followed the instructions set out in this document, please contact a technician or your local service center.

Read and follow these instructions when connecting and using your display:



- Unplug the display if you are not going to use it for an extensive period of time.
- Unplug the display if you need to clean it with a slightly damp cloth. The screen may be wiped with a dry cloth when the power is off. However, never use alcohol, solvents or ammonia-based liquids.
- Consult a service technician if the display does not operate normally when you have followed the instructions in this manual.
- The casing cover should be opened only by qualified service personnel.
- Keep the display out of direct sunlight and away from stoves or any other heat sources.
- Remove any object that could fall into the vents or prevent proper cooling of the display's electronics.
- Do not block the ventilation holes on the cabinet.
- Keep the display dry. To avoid electric shock, do not expose it to rain or excessive moisture.
- When turning off the display by detaching the power cable or DC power cord, wait for 6 seconds before re-attaching the power cable or DC power cord for normal operation.
- To avoid the risk of shock or permanent damage to the set do not expose the display to rain or excessive moisture.
- When positioning the display, make sure the power plug and outlet are easily accessible.
- **IMPORTANT:** Always activate a screen saver program during your application. If a still image in high contrast remains on the screen for an extended period of time, it may leave an 'after-image' or 'ghost image' on the front of the screen. This is a well-known phenomenon that is caused by the shortcomings inherent in LCD technology. In most cases the afterimage will disappear gradually over a period of time after the power has been switched off. Be aware that the after-image symptom cannot be repaired and is not covered under warranty.

CE Declaration of Conformity

This device complies with the requirements set out in the Council Directive on the Approximation of the Laws of the Member States relating to Electromagnetic Compatibility (2014/30/EU), Low-voltage Directive (2014/35/EU), RoHS directive (2011/65/EU) and Radio Equipment Directive (2014/53/EU).

This product has been tested and found to comply with the harmonized standards for Information Technology Equipment, these harmonized standards published under Directives of Official Journal of the European Union.

Warning:

This equipment is compliant with Class A of EN55032/CISPR 32. In a residential environment this equipment may cause radio interference.

ESD Warnings

When user close to the monitor may cause the equipment discharge and reboot to the display of main menu.

Federal Communications Commission (FCC) Notice (U.S. Only)



NOTE: This equipment has been tested and found to comply with the limits for a Class A digital device, pursuant to part 15 of the FCC Rules. These limits are designed to provide reasonable protection against harmful interference when the equipment is operated in a commercial environment. This equipment generates, uses, and can radiate radio frequency energy and, if not installed and used in accordance with the instruction manual, may cause harmful interference to radio communications. Operation of this equipment in a residential area is likely to cause harmful interference in which case the user will be required to correct the interference at his own expense.



Changes or modifications not expressly approved by the party responsible for compliance could void the user's authority to operate the equipment.

Use only an RF shielded cable that was supplied with the display when connecting this display to a computer device.

To prevent damage which may result in fire or shock hazard, do not expose this appliance to rain or excessive moisture.

Europe – EU Declaration of Conformity

This device complies with the essential requirements of the Radio Equipment Directive(2014/53/EU).The following test methods have been applied in order to prove presumption of conformity with the essential requirements of the Radio Equipment Directive(2014/53/EU):

- EN60950-1

Safety of Information Technology Equipment

- EN 62311

Assessment of electronic and electrical equipment related to human exposure restrictions for electromagnetic fields (0 Hz-300 GHz)

- EN 300 328 (For 802.11b/g/n)

Electromagnetic compatibility and Radio spectrum Matters (ERM);Wideband Transmission systems; Data transmission equipment operating in the 2,4 GHz ISM band and using spread spectrum modulation techniques; Harmonized EN covering essential requirements under article 3.2 of the R&TTE Directive

- EN 301 489-17

Electromagnetic compatibility and Radio spectrum Matters (ERM); ElectroMagnetic Compatibility (EMC) standard for radio equipment and services; Part 17: Specific conditions for 2,4 GHz wideband transmission systems and 5 GHz high performance RLAN equipment

- EN 301 489-1

Electromagnetic compatibility and Radio Spectrum Matters (ERM); ElectroMagnetic Compatibility (EMC) standard for radio equipment and services; Part 1: Common technical requirements

Taiwan:

低功率電波輻射性電機管理辦法

第十二條 經型式認證合格之低功率射頻電機，非經許可，公司、商號或使用者均不得擅自變更頻率、加大功率或變更原設計之特性及功能。

第十四條 低功率射頻電機之使用不得影響飛航安全及干擾合法通信；經發現有干擾現象時，應立即停用，並改善至無干擾時方得繼續使用。

前項合法通信，指依電信法規定作業之無線電通信。

低功率射頻電機須忍受合法通信或工業、科學及醫療用電波輻射性電機設備之干擾。

USA:

Federal Communication Commission Interference Statement

This device complies with Part 15 of the FCC Rules. Operation is subject to the following two conditions: (1) This device may not cause harmful interference, and (2) this device must accept any interference received, including interference that may cause undesired operation.

This equipment has been tested and found to comply with the limits for a Class B digital device, pursuant to Part 15 of the FCC Rules. These limits are designed to provide reasonable protection against harmful interference in a residential installation. This equipment generates, uses and can radiate radio frequency energy and, if not installed and used in accordance with the instructions, may cause harmful interference to radio communications. However, there is no guarantee that interference will not occur in a particular installation. If this equipment does cause harmful interference to radio or television reception, which can be determined by turning the equipment off and on, the user is encouraged to try to correct the interference by one of the following measures:

- Reorient or relocate the receiving antenna.
- Increase the separation between the equipment and receiver.
- Connect the equipment into an outlet on a circuit different from that to which the receiver is connected.
- Consult the dealer or an experienced radio/TV technician for help.

FCC Caution: Any changes or modifications not expressly approved by the party responsible for compliance could void the user's authority to operate this equipment.

This transmitter must not be co-located or operating in conjunction with any other antenna or transmitter.

Canada:

Industry Canada statement:

This device complies with RSS-247 of the Industry Canada Rules. Operation is subject to the following two conditions: (1) This device may not cause harmful interference, and (2) this device must accept any interference received, including interference that may cause undesired operation.

Ce dispositif est conforme à la norme CNR-247 d'Industrie Canada applicable aux appareils radio exempts de licence. Son fonctionnement est sujet aux deux conditions suivantes: (1) le dispositif ne doit pas produire de brouillage préjudiciable, et (2) ce dispositif doit accepter tout brouillage reçu, y compris un brouillage susceptible de provoquer un fonctionnement in

Brazil:

ANATEL RF STATEMENT

Per Article 6 of Resolution 506, equipment of restricted radiation must carry the following statement in a visible location

“Este equipamento opera em caráter secundário, isto é, não tem direito a proteção contra interferência prejudicial, mesmo de estações do mesmo tipo, e não pode causar interferência a sistemas operando em caráter primário.”

ANATEL BODY SAR STATEMENT

“Este produto atende aos requisitos técnicos aplicados, incluindo os limites de exposição da Taxa de Absorção Específica referente a campos elétricos, magnéticos e eletromagnéticos de radiofrequência, de acordo com as resoluções nº303/2002 e 533/2009. Este produto atende às diretrizes de exposição à RF na posição normal de uso a pelo menos X centímetros longe do corpo, tendo sido os ensaios de SAR para corpo realizado a X cm de acordo com o informativo de recomendação apresentado no manual do fabricante.”

Polish Center for Testing and Certification Notice

The equipment should draw power from a socket with an attached protection circuit (a three-prong socket). All equipment that works together (computer, display, printer, and so on) should have the same power supply source.

The phasing conductor of the room's electrical installation should have a reserve short-circuit protection device in the form of a fuse with a nominal value no larger than 16 amperes (A).

To completely switch off the equipment, the power supply cable must be removed from the power supply socket, which should be located near the equipment and easily accessible.

A protection mark “B” confirms that the equipment is in compliance with the protection usage requirements of standards PN-93/T-42107 and PN-89/E-06251.

Wymagania Polskiego Centrum Badań i Certyfikacji

Urządzenie powinno być zasilane z gniazda z przyłączonym obwodem ochronnym (gniazdo z kolkiem). Współpracujące ze sobą urządzenia (komputer, monitor, drukarka) powinny być zasilane z tego samego źródła.

Instalacja elektryczna pomieszczenia powinna zawierać w przewodzie fazowym rezerwową ochronę przed zwarciami, w postaci bezpiecznika o wartości znamionowej nie większej niż 16A (amperów).

W celu całkowitego wyłączenia urządzenia z sieci zasilania, należy wyjąć wtyczkę kabla zasilającego z gniazdką, które powinno znajdować się w pobliżu urządzenia i być łatwo dostępne.

Znak bezpieczeństwa "B" potwierdza zgodność urządzenia z wymaganiami bezpieczeństwa użytkownika zawartymi w PN-93/T-42107 i PN-89/E-06251.

Pozostałe instrukcje bezpieczeństwa

- Nie należy używać wtyczek adapterowych lub usuwać kolka obwodu ochronnego z wtyczki. Jeżeli konieczne jest użycie przedłużacza to należy użyć przedłużacza 3-żyłowego z prawidłowo połączonym przewodem ochronnym.
- System komputerowy należy zabezpieczyć przed nagłymi, chwilowymi wzrostami lub spadkami napięcia, używając eliminatora przepięć, urządzenia dopasowującego lub bezzakłóceńowego źródła zasilania.
- Należy upewnić się, aby nic nie leżało na kablach systemu komputerowego, oraz aby kable nie były umieszczone w miejscu, gdzie można byłoby na nie nadeptywać lub potykać się o nie.
- Nie należy rozlewać napojów ani innych płynów na system komputerowy.
- Nie należy wpychać żadnych przedmiotów do otworów systemu komputerowego, gdyż może to spowodować pożar lub porażenie prądem, poprzez zwarcie elementów wewnętrznych.
- System komputerowy powinien znajdować się z dala od grzejników i źródeł ciepła. Ponadto, nie należy blokować otworów wentylacyjnych. Należy unikać kładzenia luźnych papierów pod komputer oraz umieszczania komputera w ciasnym miejscu bez możliwości cyrkulacji powietrza wokół niego.

Electric, Magnetic and Electromagnetic Fields ("EMF")

1. We manufacture and sell many products targeted at consumers, which, like any electronic apparatus, in general have the ability to emit and receive electromagnetic signals.
2. One of our leading Business Principles is to take all necessary health and safety measures for our products, to comply with all applicable legal requirements and to stay well within the EMF standards applicable at the time of producing the products.
3. We are committed to develop, produce and market products that cause no adverse health effects.
4. We confirm that if its products are handled properly for their intended use, they are safe to use according to scientific evidence available today.
5. We play an active role in the development of international EMF and safety standards, enabling us to anticipate further developments in standardization for early integration in its products.

Information for U.K. only

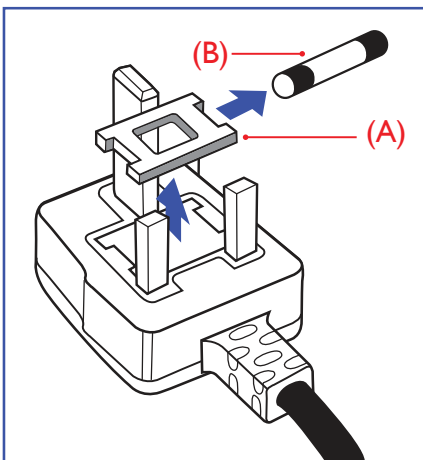

WARNING - THIS APPLIANCE MUST BE EARTHED.

Important:

This apparatus is supplied with an approved moulded 13A plug. To change a fuse in this type of plug proceed as follows:+

1. Remove fuse cover and fuse.
2. Fit new fuse which should be a BS 1362 5A, A.S.T.A. or BSI approved type.
3. Refit the fuse cover.

If the fitted plug is not suitable for your socket outlets, it should be cut off and an appropriate 3-pin plug fitted in its place.

If the mains plug contains a fuse, this should have a value of 5A. If a plug without a fuse is used, the fuse at the distribution board should not be greater than 5A.

NOTE: The severed plug must be destroyed to avoid a possible shock hazard should it be inserted into a 13A socket elsewhere.

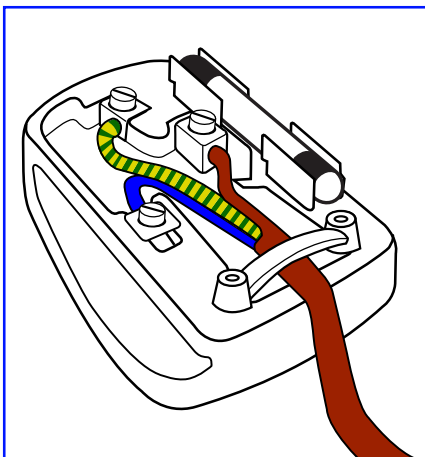

How to connect a plug

The wires in the mains lead are coloured in accordance with the following code:

BLUE - "NEUTRAL" ("N")

BROWN - "LIVE" ("L")

GREEN & YELLOW - "EARTH" ("E")

1. The GREEN & YELLOW wire must be connected to the terminal in the plug which is marked with the letter "E" or by the Earth symbol or coloured GREEN or GREEN & YELLOW.
2. The BLUE wire must be connected to the terminal which is marked with the letter "N" or coloured BLACK.
3. The BROWN wire must be connected to the terminal which marked with the letter "L" or coloured RED.

Before replacing the plug cover, make certain that the cord grip is clamped over the sheath of the lead - not simply over the three wires.

North Europe (Nordic Countries) Information

Placering/Ventilation

VARNING:

FÖRSÄKRA DIG OM ATT HUVUDBRYTARE OCH UTTAG ÄR LÄTÅTKOMLIGA, NÄR DU STÄLLER DIN UTRUSTNING PÅPLATS.

Placering/Ventilation

ADVARSEL:

SØRG VED PLACERINGSFOR, AT NETLEDNINGENS STIK OG STIKKONTAKT ER NEMT TILGÆNGELIGE.

Paikka/Ilmankierto

VAROITUS:

SJJOITA LAITE SITEN, ETTÄ VERKKOJOHTO VOIDAAN TARVITTAESSA HELPOSTI IRROTTAA PISTORASIESTA.

Plassering/Ventilasjon

ADVARSEL:

NÅR DETTE UTSTYRET PLASSERES, MÅ DU PASSE PÅ AT KONTAKTENE FOR STØMTILFØRSEL ER LETTE Å NÅ.

China RoHS

电子电气产品有害物质限制使用标识要求 (中国RoHS法规标识要求) 产品中有害物质的名称及含量。

零部件名称		有害物质					
		铅 (Pb)	汞 (Hg)	镉 (Cd)	六价铬 (Cr (VI))	多溴联苯 (PBB)	多溴二苯醚 (PBDE)
塑料外框		○	○	○	○	○	○
后壳		○	○	○	○	○	○
LCD panel	CCFL	×	×	○	○	○	○
	LED	×	○	○	○	○	○
电路板组件*		×	○	○	○	○	○
底座		○	○	○	○	○	○
电源线		×	○	○	○	○	○
其他线材		×	○	○	○	○	○
遥控器		×	○	○	○	○	○

*: 电路板组件包括印刷电路板及其构成的零部件, 如电阻、电容、集成电路、连接器等。

本表格依据SJ/T 11364的规定编制。

○: 表示该有害物质在该部件所有均质材料中的含量均在 GB/T 26572 标准规定的限量要求以下。

×: 表示该有害物质至少在该部件的某一均质材料中的含量超出 GB/T 26572 标准规定的限量要求。

上表中打“×”的部件中, 应功能需要, 部分有害物质含量超出GB/T 26572规定的限量要求, 但是符合欧盟RoHS法规要求(属于豁免部分)。

备注: 上表仅做为范例, 实际标示时应依照各产品的实际部件及所含有害物质进行标示。



环保使用期限

此标识指期限(十年), 电子电气产品中含有的有害物质在正常使用的条件下不会发生外泄或突变, 电子电气产品用户使用该电子电气产品不会对环境造成严重污染或对其人身、财产造成严重损害的期限。

中国能源效率标识

根据中国大陆《能源效率标识管理办法》，本显示器符合以下要求

能源效率 (cd/W)	>1.05
能效等级	1 级
能效标准	GB 21520-2008

详细有关信息请查阅中国能效标识网：<http://www.energylabel.gov.cn/>

《废弃电器电子产品回收处理管理条例》提示性说明

为了更好地关爱及保护地球，当用户不再需要此产品或产品寿命终止时，请遵守国家废弃电器电子产品回收处理相关法律法规，将其交给当地具有国家认可的回收处理资质的厂商进行回收处理。

警告

此为A级产品。在生活环境中，该产品可能会造成无线电干扰。在这种情况下，可能需要用户对干扰采取切实可行的措施。

設備名稱：液晶彩色顯示器，型號（型式）：55BDL4050D

單元	限用物質及其化學符號					
	鉛 (Pb)	汞 (Hg)	鎘 (Cd)	六價鉻 (Cr ⁶⁺)	多溴聯苯 (PBB)	多溴二苯醚 (PBDE)
塑料外框	○	○	○	○	○	○
後殼	○	○	○	○	○	○
LCD panel	—	○	○	○	○	○
電路板組件	—	○	○	○	○	○
底座	○	○	○	○	○	○
電源線	—	○	○	○	○	○
其他線材	—	○	○	○	○	○
遙控器	—	○	○	○	○	○

備考1. “○” 係指該項限用物質之百分比含量未超出百分比含量基準值。
備考2. “—” 係指該項限用物質為排除項目。

警語：使用過度恐傷害視力。

注意事項：

- (1) 使用30分鐘請休息10分鐘。
- (2) 未滿2歲幼兒不看螢幕，2歲以上每天看螢幕不要超過1小時。

End-of-Life Disposal

Your new Public Information Display contains materials that can be recycled and reused. Specialized companies can recycle your product to increase the amount of reusable materials and to minimize the amount to be disposed of.

Please find out about the local regulations on how to dispose of your old display from your local Philips dealer.

(For customers in Canada and U.S.A.)

This product may contain lead and/or mercury. Dispose of in accordance to local-state and federal regulations. For additional information on recycling contact www.eia.org (Consumer Education Initiative)

Waste Electrical and Electronic Equipment-WEEE

Attention users in European Union private households



This marking on the product or on its packaging illustrates that, under European Directive 2012/19/EU governing used electrical and electronic appliances, this product may not be disposed of with normal household waste. You are responsible for disposal of this equipment through a designated waste electrical and electronic equipment collection. To determine the locations for dropping off such waste electrical and electronic, contact your local government office, the waste disposal organization that serves your household or the store at which you purchased the product.

Attention users in United States:

Please dispose of according to all Local, State and Federal Laws. For the disposal or recycling information, contact: www.mygreenelectronics.com or www.eiae.org.

End of Life Directives-Recycling



Your new Public Information Display contains several materials that can be recycled for new users.

Please dispose of according to all Local, State, and Federal laws



As an ENERGY STAR Partner, we have determined that this product meets the ENERGY STAR guidelines for energy efficiency.

Restriction on Hazardous Substances statement (India)

This product complies with the "India E-waste Rule 2011" and prohibits use of lead, mercury, hexavalent chromium, polybrominated biphenyls or polybrominated diphenyl ethers in concentrations exceeding 0.1 weight % and 0.01 weight % for cadmium, except for the exemptions set in Schedule 2 of the Rule.

E-Waste Declaration for India



This symbol on the product or on its packaging indicates that this product must not be disposed of with your other household waste. Instead it is your responsibility to dispose of your waste equipment by handing it over to a designated collection point for the recycling of waste electrical and electronic equipment. The separate collection and recycling of your waste equipment at the time of disposal will help to conserve natural resources and ensure that it is recycled in a manner that protects human health and the environment. For more information about where you can drop off your waste equipment for recycling in India please visit the below web link.

<http://www.india.philips.com/about/sustainability/recycling/index.page>

Batteries



For EU: The crossed-out wheeled bin implies that used batteries should not be put to the general household waste! There is a separate collection system for used batteries, to allow proper treatment and recycling in accordance with legislation.

Please contact your local authority for details on the collection and recycling schemes.

For Switzerland: The used battery is to be returned to the selling point.

For other non-EU countries: Please contact your local authority for correct method of disposal of the used battery.

According to EU directive 2006/66/EC, the battery can't be disposed improperly. The battery shall be separated to collect by local service.

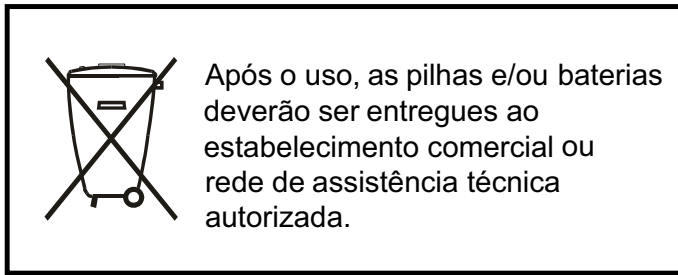

警告使用者：

此為甲類資訊技術設備，於居住環境中使用時，可能會造成射頻擾動，在此種情況下，使用者會被要求採取某些適當的對策。

Table Of Contents

1. Unpacking and Installation	1
1.1. Unpacking.....	1
1.2. Package Contents.....	1
1.3. Installation Notes.....	1
1.4. Installing and Removing Table Stands (optional).....	2
1.5. Mounting on a Wall.....	3
1.5.1. VESA Grid.....	3
1.6. Mounting in Portrait Position.....	4
1.6.1. How to use the logo guider for portrait position.....	4
1.6.2. How to remove the logo.....	4
1.7. Operating Instructions of Edge Alignment Kit.....	5
1.7.1. Installing Edge Alignment Kit.....	5
2. Parts and Functions	6
2.1. Control Panel.....	6
2.2. Input/Output Terminals.....	7
2.3. Remote Control.....	8
2.3.1. General functions.....	8
2.3.2. IR Remote Control.....	10
2.3.3. Remote Control buttons on Android source.....	11
2.3.4. Inserting the batteries in the remote control.....	13
2.3.5. Handling the remote control.....	13
2.3.6. Operating range of the remote control.....	13
3. Connecting External Equipment	14
3.1. Connecting External Equipment (DVD/VCR/VCD).....	14
3.1.1. Using HDMI video input.....	14
3.2. Connecting a PC.....	14
3.2.1. Using DVI-I input.....	14
3.2.2. Using DVI input.....	14
3.2.3. Using HDMI input.....	15
3.2.4. Using DisplayPort input.....	15
3.3. Connecting Audio Equipment.....	15
3.3.1. Connecting an external audio device.....	15
3.4. Connecting Multiple Displays in a Daisy-chain Configuration.....	16
3.4.1. Display control connection.....	16
3.4.2. Digital video connection.....	16
3.4.3. Analog video connection.....	17
3.5. IR connection.....	17
3.6. IR Pass-through Connection.....	17
4. Operation	18
4.1. Watch the Connected Video Source.....	18
4.2. Change Picture Format.....	18
4.3. Android Launcher.....	18
4.4. Media Player introduction.....	19
4.5. Browser manual.....	21
4.6. PDF reader play.....	23
4.7. SmartCMS.....	26
4.8. Custom app.....	27
4.8.1. OSD Menu operation.....	27
4.8.2. Function Introduction.....	27
5. signage display	28
5.1. Setting.....	28
5.2. Wi-Fi.....	28
5.3. Ethernet.....	28
5.3.1. DHCP.....	28
5.3.2. Static IP.....	28
5.4. Signage Display.....	29
5.4.1. General Settings.....	29
5.4.2. Server Settings.....	31
5.4.3. Source Settings.....	34
5.5. System Tools.....	36
5.5.1. Clear Storage.....	36
5.5.2. Factory Reset.....	36
5.5.3. Import & Export.....	36
5.6. Storage.....	37
5.7. Apps.....	37
5.8. Date & time.....	37
5.9. Developer options.....	37
5.10. About.....	38
5.10.1. System updates.....	38
5.11. Supplementary.....	38
5.11.1. Rotation.....	38
5.11.2. ASCII Table.....	39
6. OSD Menu	40
6.1. Navigating the OSD Menu.....	40
6.1.1. Navigating the OSD menu using the remote control.....	40
6.1.2. Navigating the OSD menu using the display's control buttons.....	40
6.2. OSD Menu Overview.....	40
6.2.1. Picture menu.....	40
6.2.2. Screen menu.....	41
6.2.3. Audio menu.....	42
6.2.4. PIP menu.....	43
6.2.5. Configuration1 menu.....	43
6.2.6. Configuration2 menu.....	44
6.2.7. Advanced option menu.....	46

7.	USB device compatibility.....	50
8.	Input Mode.....	52
9.	Pixel Defect Policy.....	53
9.1.	Pixels and Sub-Pixels.....	53
9.2.	Types of Pixel Defects + Dot Definition.....	53
9.3.	Bright Dot Defects.....	53
9.4.	Dark Dot Defects.....	54
9.5.	Proximity of Pixel Defects.....	54
9.6.	Pixel Defect Tolerances.....	54
9.7.	MURA.....	54
10.	Cleaning and Troubleshooting.....	55
10.1.	Cleaning.....	55
10.2.	Troubleshooting.....	56
11.	Technical Specifications.....	57

1. Unpacking and Installation

1.1. Unpacking

- This product is packed in a carton, together with the standard accessories.
- Any other optional accessories will be packed separately.
- Due to the size and weight of this display it is recommended for two people to move it.
- After opening the carton, ensure that the contents are complete and in good condition.

1.2. Package Contents

Please verify that you received the following items with your package content:

- LCD display
- Remote control with AAA batteries
- Power cord (1.8 m)
- RS232 cable (1.8 m)
- RS232 daisy-chain cable (1.8 m)
- Quick start guide
- Logo guider & logo
- Edge Alignment Kit-1: 2PCS
- Edge Alignment Kit-2: 1PCS
- Thumb Screw: 8PCS



Quick start guide

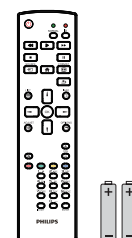

Remote Control and AAA Batteries



Thumb Screw

* The supplied power cord varies depending on destination.

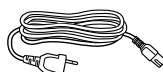

Power Cord



RS232 daisy-chain cable

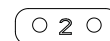

Edge Alignment Kit-1



Logo guider

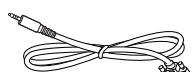

RS232 Cable

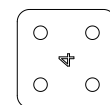

Edge Alignment Kit-2

* Differences according to regions.

Display design and accessories may differ from those illustrated above.

NOTES:

- For all other regions, apply a power cord that conforms to the AC voltage of the power socket and has been approved by and complies with the safety regulations of the particular country (Type H05VV-F ,2G or 3G, 0.75 or 1mm² should be used).
- You might like to save the package box and packing material for shipping the display.

1.3. Installation Notes

- Due to the high power consumption, always use the plug exclusively designed for this product. If an extended line is required, please consult your service agent.
- The product should be installed on a flat surface to avoid tipping. The distance between the back of the product and the wall should be maintained for proper ventilation. Avoid installing the product in the kitchen, bathroom or any other places with high humidity so as not to shorten the service life of the electronic components.
- The product can normally operate only under 3000m in altitude. In installations at altitudes above 3000m, some abnormalities may be experienced.

1.4. Installing and Removing Table Stands (optional)

Step 1- Put on the table

Lay a protective sheet on the table, which was wrapped around the display when it was packaged, beneath the screen surface so as not to scratch the screen face.

Step 2- Fix the tube to the display (by using M6xL41 screws)

Please refer to the following drawing to know the position of screws.

Step 3- Set up the stand (by using thumb)

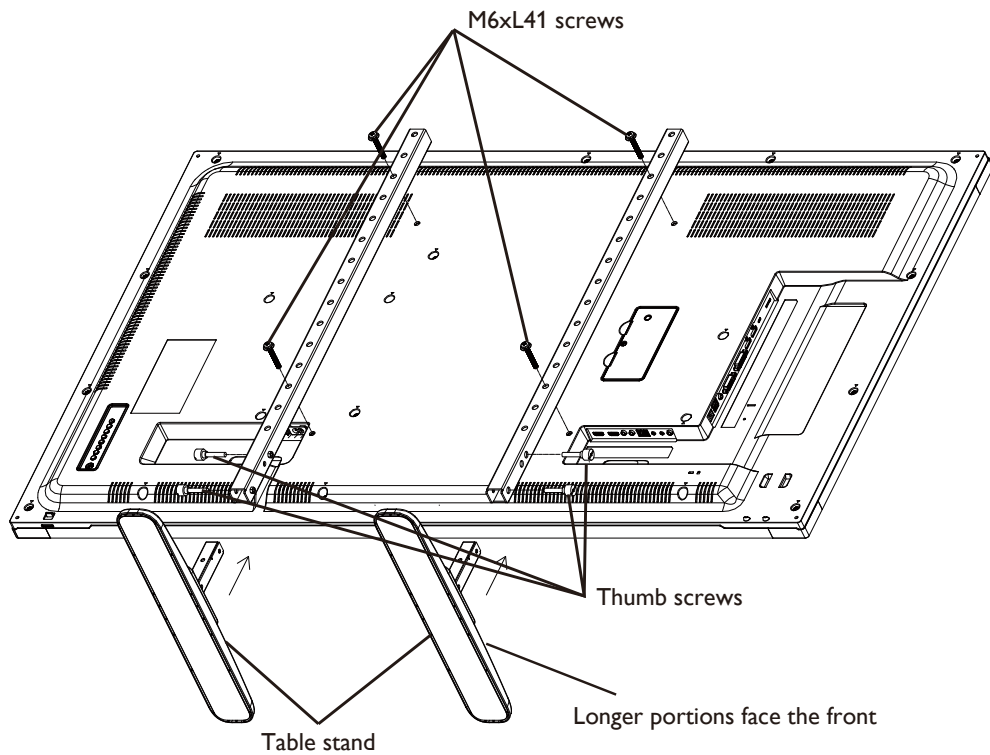

To remove table stands:

1. Power off the display.
2. Spread a protective sheet on a flat surface.
3. Place the display face-down on the protective sheet.
4. Remove screws using a screwdriver and place them in a safe place for reuse.

1.5. Mounting on a Wall

To mount this display to a wall, you will have to obtain a standard wall-mounting kit (commercially available). We recommend using a mounting interface that complies with TUV-GS and/or UL1678 standard.

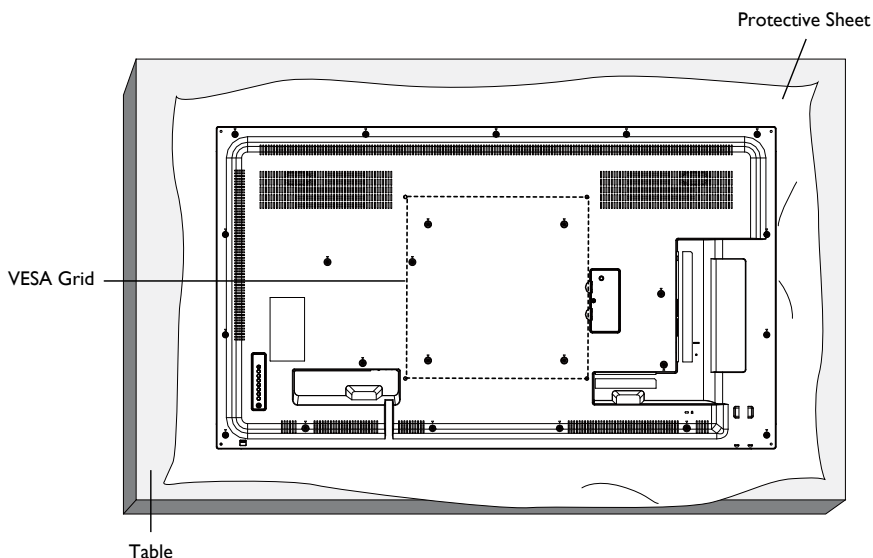

1. Lay a protective sheet on a table, which was wrapped around the display when it was packaged, beneath the screen surface so as not to scratch the screen face.
2. Ensure you have all accessories for mounting this display (wall mount, ceiling mount, table stand, etc).
3. Follow the instructions that come with the base mounting kit. Failure to follow correct mounting procedures could result in damage to the equipment or injury to the user or installer. Product warranty does not cover damage caused by improper installation.
4. For the wall-mounting kit, use M6 mounting screws (having a length 10 mm longer than the thickness of the mounting bracket) and tighten them securely.

1.5.1. VESA Grid

55BDL4050D	400(H) x 400(V) mm
------------	--------------------

Caution:

To prevent the display from falling:

- For wall or ceiling installation, we recommend installing the display with metal brackets which are commercially available. For detailed installation instructions, refer to the guide received with the respective bracket.
- To lessen the probability of injury and damage resulting from fall of the display in case of earthquake or other natural disaster; be sure to consult the bracket manufacturer for installation location.

Ventilation Requirements for enclosure locating

To allow heat to disperse, leave space between surrounding objects as shown in the diagram below.

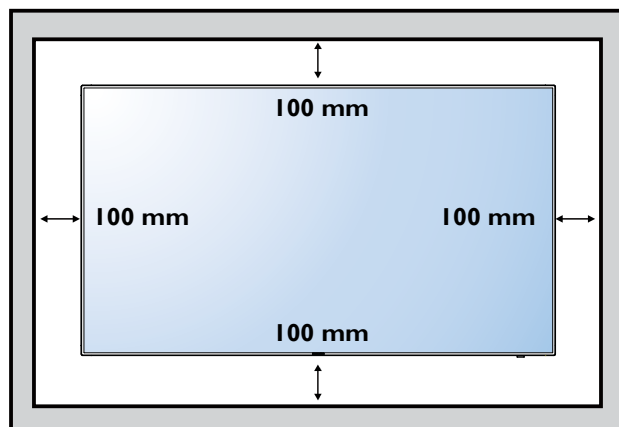

1.6. Mounting in Portrait Position

This display can be installed in portrait position.

1. Remove the table stand, if attached.
2. Rotate 90 degrees counter-clockwise. The "PHILIPS" logo should be on the RIGHT side when facing the display.

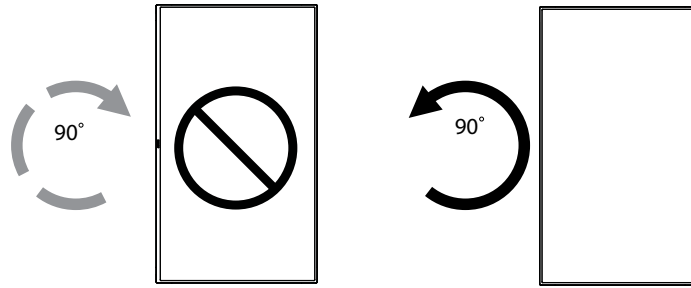

1.6.1. How to use the logo guider for portrait position

1. Put the guider on the lower-left corner of the front bezel of the display. Fold down both of its edges.
2. Peel off the protective film at the back of the "PHILIPS" logo sticker. Hold and press the guider with your left hand. Put the "PHILIPS" logo sticker with its adhesive side down into the logo hole with your right hand, and press to make it stick tightly onto the front bezel.
3. Remove the guider.

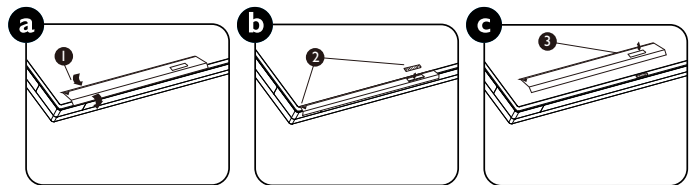

1.6.2. How to remove the logo

1. Prepare a piece of paper with a cutting area of logo as a protector to prevent the front bezel from scratching.
2. Using a knife, carefully remove the logo sticker with the paper placing beneath.
3. Tear off the logo sticker.

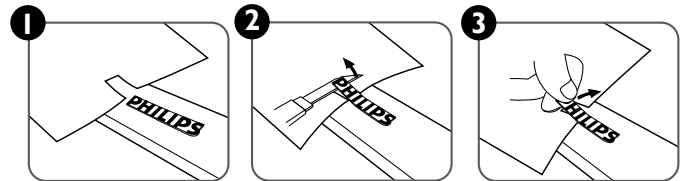

NOTE: When installing the display on a wall, please consult a professional technician for proper installation. We accept no liability for installations not performed by a professional technician.

1.7. Operating Instructions of Edge Alignment Kit

1.7.1. Installing Edge Alignment Kit

- Using "Edge Alignment Kit-1" on adjacent two displays.
- Install the "Edge Alignment Kit-1" with 2 PCS of M4 screw.

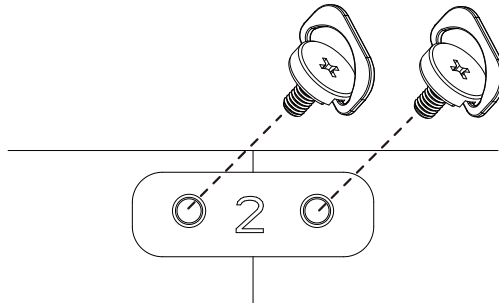

- Using "Edge Alignment Kit-2" on adjacent four displays.

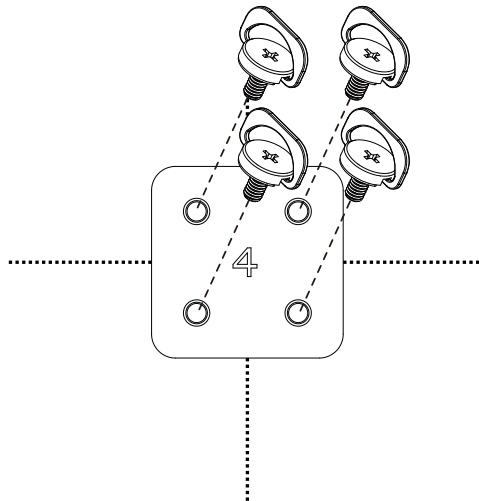

NOTE: When installing the edge alignment kit, please consult a professional technician for proper installation. We accept no liability for installations not performed by a professional technician.

2. Parts and Functions

2.1. Control Panel

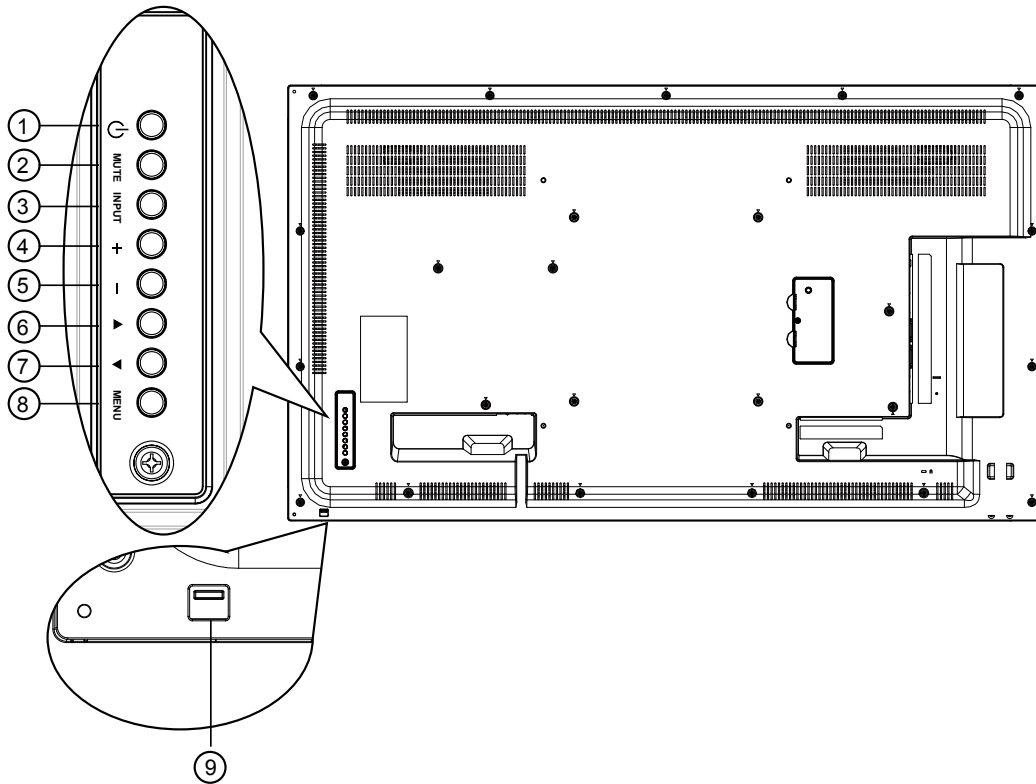

① [Power] button

Use this button to turn the display on or put the display to standby.

② [MUTE] button

Switch the audio mute ON/OFF.

③ [INPUT] button

Choose the input source.

- Used as [OK] button in the On-Screen-Display menu.

④ [++] button

Increase the adjustment while OSD menu is on, or increase the audio output level while OSD menu is off.

⑤ [--] button

Decrease the adjustment while OSD menu is on, or decrease the audio output level while OSD menu is off.

⑥ [▲] button

Move the highlight bar up to adjust the selected item while OSD menu is on.

⑦ [▼] button

Move the highlight bar down to adjust the selected item while OSD menu is on.

⑧ [MENU] button

Return to previous menu while OSD menu is on, or to activate the OSD menu when OSD menu is off.

⑨ Remote control sensor and power status indicator

- Receives command signals from the remote control.
- Indicates the operating status of the display without OPS:
 - Lights green when the display is turned on
 - Lights red when the display is in standby mode
 - Lights amber when the display enters APM mode
 - When {SCHEDULE} is enabled, the light blinks green and red
 - If the light blinks red, it indicates that a failure has been detected
 - Lights off when the main power of the display is turned off
- Pull down the lens to have better remote control performance and easy to observe the light information of power status.
- Push up the lens before mounting the display for video wall application.
- Pull/Push the lens until hearing the click sound.

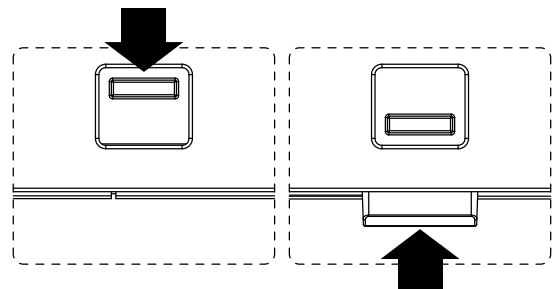

2.2. Input/Output Terminals

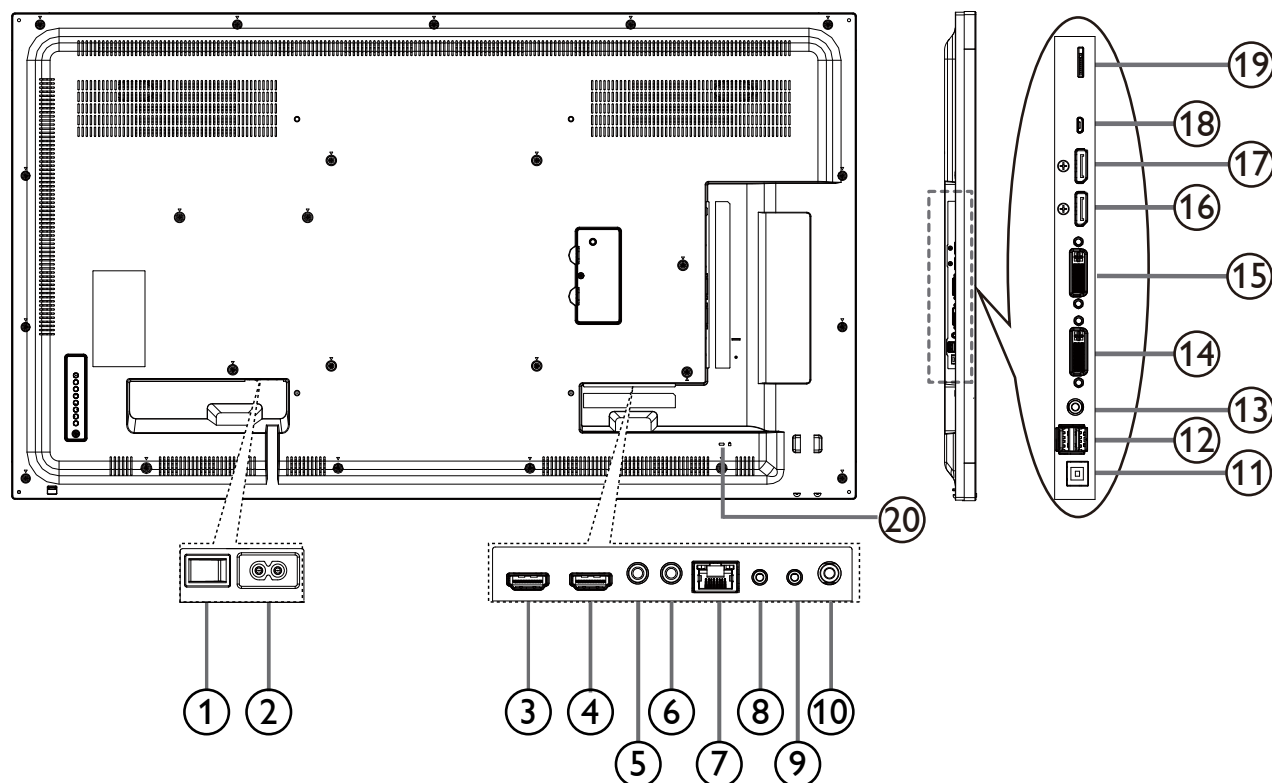

① **AC SWITCH**

Switch the main power on/off.

② **AC IN**

AC power input from the wall outlet.

③ **HDMI1 IN** / ④ **HDMI2 IN**

HDMI video/audio input.

⑤ **IR IN** / ⑥ **IR OUT**

IR signal input / output for the loop-through function.

⑦ **RJ-45**

LAN control function for the use of remote control signal from control center.

⑧ **RS232 IN** / ⑨ **RS232 OUT**

RS232 network input / output for the loop-through function.

⑩ **Audio OUT**

Audio output to external AV device.

⑪ **USB PORT B**

Touch connector to PC.

⑫ **USB PORT A**



⑬ **PC LINE IN**

Audio input for VGA source (3.5mm stereo phone).

⑭ **DVI IN**

DVI-I video input.

⑮ **DVI OUT**

DVI or VGA video output.

⑯ **DisplayPort IN** / ⑰ **DisplayPort OUT**

DisplayPort video input / output.

⑱ **MICRO USB**

Connect your USB storage device.

⑲ **MICRO SD CARD**

Connect your MICRO SD CARD.

⑳ **SECURITY LOCK**

Used for security and theft prevention.

2.3. Remote Control

2.3.1. General functions

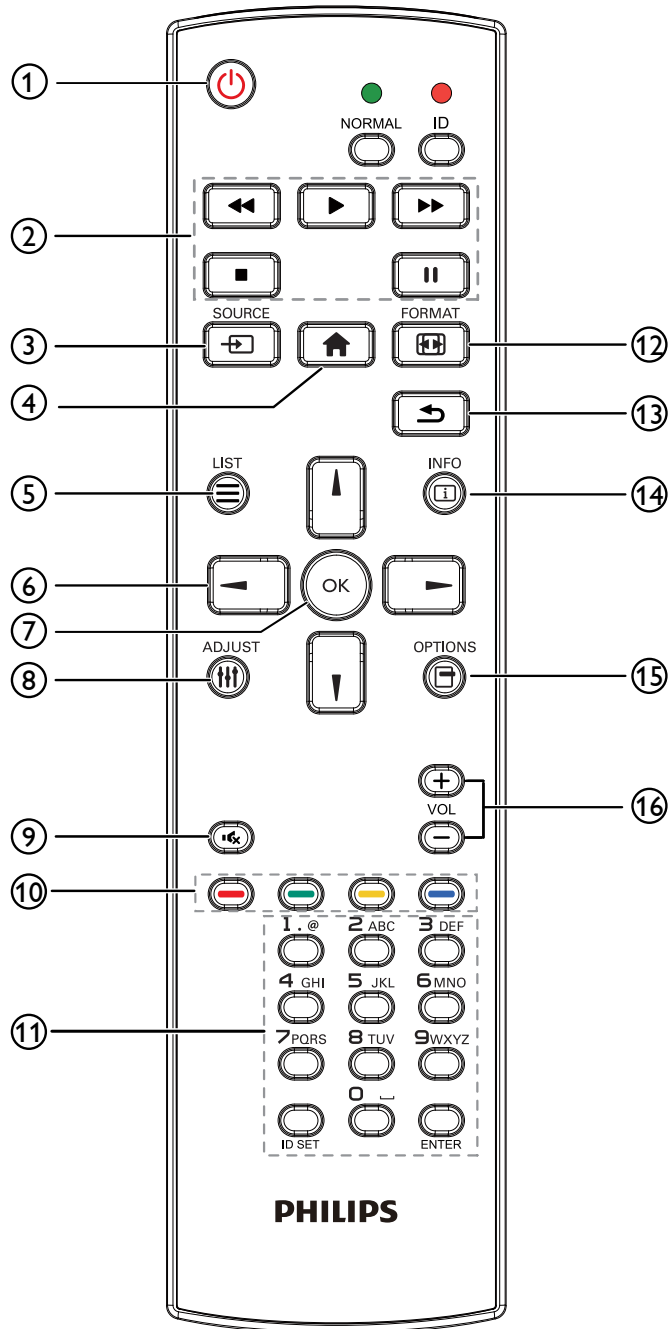

① [POWER] POWER button

Power ON/OFF.

② [PLAY] buttons

Control playback of media files.(for Media Input only)

Freeze feature

Pause: Freeze hot key for all inputs content.

Play: Unfreeze hot key for all input content.

③ [SOURCE] SOURCE button

Root Menu: Go to Video source OSD.

④ [HOME] HOME button

Root Menu: Go to Main Menu OSD.

Others: Exit OSD.

⑤ [LIST] LIST button

No function.

⑥ NAVIGATION buttons



Root Menu: Go to Smart picture OSD.

Main Menu: Move the highlight bar up to adjust the selected item.

IR Daisy Chain Menu: Increase controlled Group ID number.



Root Menu: Go to Audio source OSD.

Main Menu: Move the highlight bar down to adjust the selected item.

IR Daisy Chain Menu: Decrease controlled Group ID number.



Main Menu: go to previous level menu.

Source Menu: Exit source menu.

Volume Menu: Decrease Audio Volume.



Main Menu: go to next level menu or set selected option.

Source Menu: Go to selected source.

Volume Menu: Increase Audio Volume.

⑦ [OK] button

Root Menu: Go to IR daisy chain OSD in Primary/Secondary mode.

Main Menu: Confirm an entry or selection.

⑧ [ADJUST] ADJUST button

Go to Auto Adjust OSD for VGA only.

⑨ [MUTE] MUTE button

Toggle Audio Mute/Unmute.

⑩ [COLOR] COLOR buttons

Choose tasks or options.(for Media Input only)

[GREEN] Hot key for Window selection function.

11 [Number/ ID SET/ ENTER] button

Enter text for network setting.

Press to set the display ID. Refer to **2.3.2. ID Remote Control** for more detail.

12  FORMAT button

Change Image Zoom Mode [Full][4:3][1:1][16:9][21:9][Custom].

13  BACK button

Return to the previous menu page or exit from the previous function.

14  INFO button

Show Information OSD

15  OPTIONS button

No function.

16  VOLUME button

Adjust volume.

2.3.2. ID Remote Control

You can set the remote control ID when you want to use this remote control on one of several different displays.

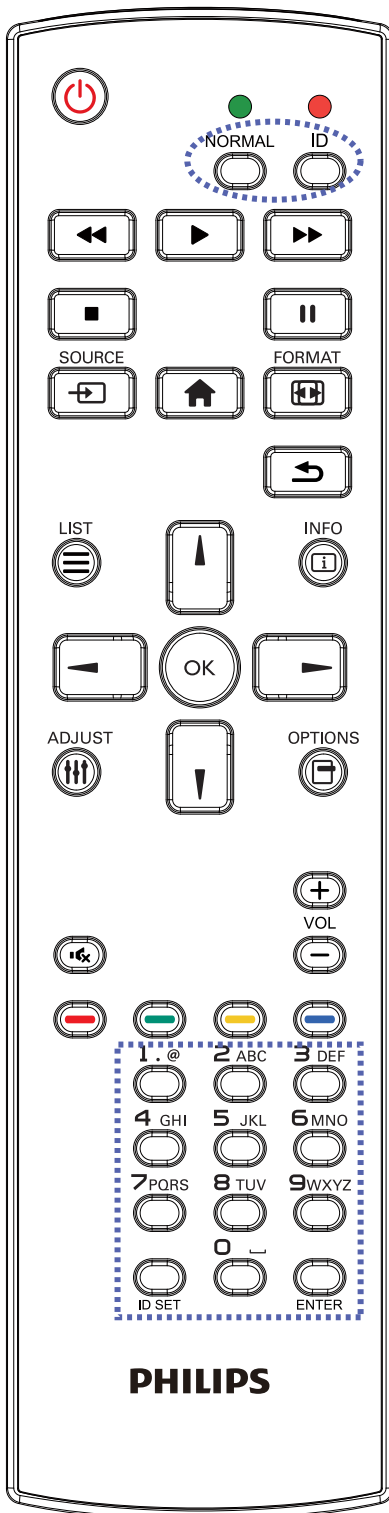

Press [ID] button. The red LED blinks twice.

1. Press [ID SET] button for more than 1 second to enter the ID Mode. The red LED lights up.
Press the [ID SET] button again will exit the ID Mode. The red LED lights off.

Press the digit numbers [0] ~ [9] to select the display you want to control.

For example: press [0] and [1] for display No.1, press [1] and [1] for display No.11.

The numbers available are from [01] ~ [255].

2. Not pressing any button within 10 seconds will exit the ID Mode.
3. If an error pressing of buttons other than the digits occurred, wait 1 second after the red LED lights off and then lights up again, then press the correct digits again.
4. Press [ENTER] button to confirm. The red LED blinks twice and then lights off.

NOTE:

- Press [NORMAL] button. The green LED blinks twice, indicating the display is in normal operation.
- It is necessary to set up the ID number for each display before selecting its ID number.

2.3.3. Remote Control buttons on Android source

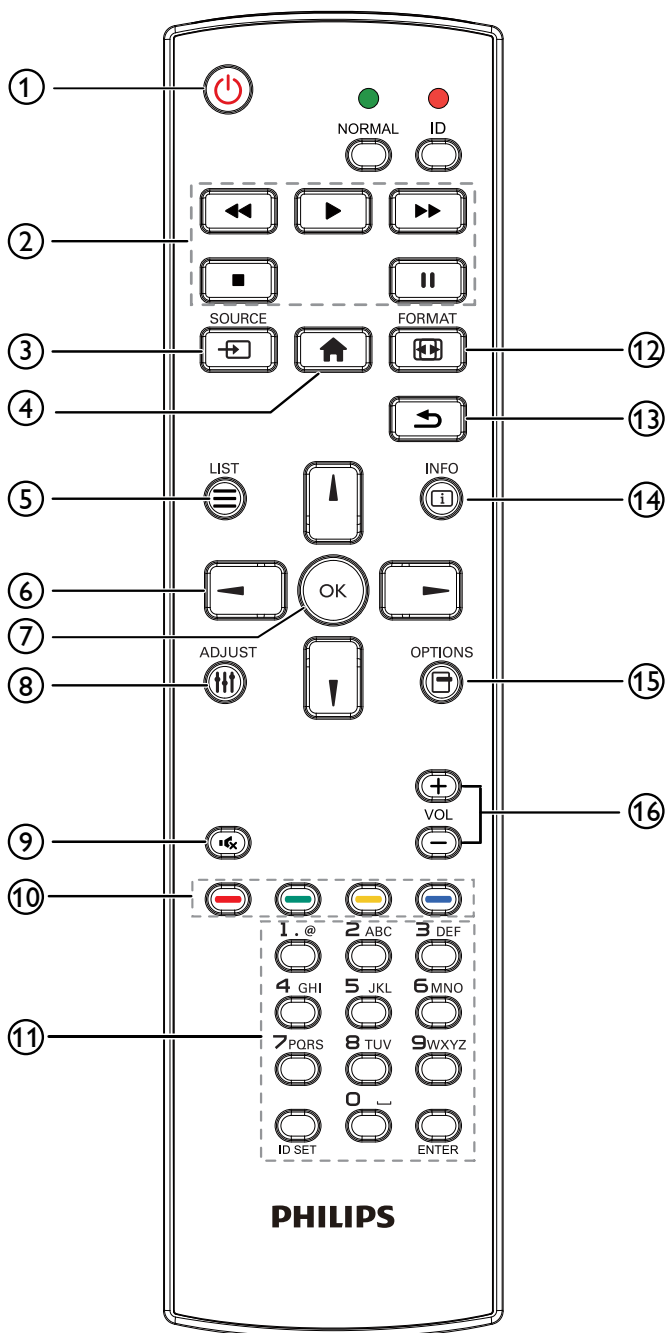

① [POWER] POWER button

Turn the display on or put the display to standby.

The button is only controlled by Scalar.

② [PLAY] buttons

1. Control playback of media(video/audio/picture) files.

There are 4 ways to play media files.

1) File Manager

Find the media file from the File Manager and select it to play.

2) Media Player -> Compose -> edit or new add playlist -> choose any media files -> press to play the media file directly.

3) Media Player -> Play -> choose non-empty play list -> press to play all the media files in the play list.

4) Set media playlist in Boot on Source or Schedule by OSD menu.

2. Play PDF file

There are 3 ways to play media files.

1) File Manager

Find the pdf file from the File Manager and select it to play.

2) PDF Player -> Play -> choose non-empty play list -> press to play all the PDF files in the play list.

3) Set pdf playlist in Boot on Source or Schedule by OSD menu.

3. When playing PDF, video or music, press to stop playing.

Then if pressing again, playing will be started from the beginning of the file.

4. When playing PDF, video or music, press button to pause playing.

5. All media or pdf files should be put at the folder, which is named "philips" with sub-folder, under the root directory of the specified storage (internal/USB/SD Card). All sub-folders (video/photo/music/pdf) are named by media types and shouldn't be changed.

videos: {root dir of storage}/philips/video/

photos: {root dir of storage}/philips/photo/

music : {root dir of storage}/philips/music/

pdfs : {root dir of storage}/philips/pdf/

Note that the root directories of three storages are

Internal storage: /sdcard

USB storage: /mnt/usb_storage

SD card : /mnt/external_sd

③ [SOURCE] SOURCE button

Choose input source.

The button is only controlled by Scalar.

④ [HOME] HOME button

Access OSD menu.





The button is only controlled by Scalar.

⑤ [LIST] LIST button

1. In the content of the web page, move the focus up to the next clickable items.

2. Move the focus up to the next control or widget such as buttons.

⑥ NAVIGATION buttons

1. Navigate through menus and choose items.
2. In the content of the web page, these buttons are to control the scroll bar of the screen. Press  or  is for moving vertical scroll bar up or down. Press  or  is for moving horizontal scroll bar left or right.

3. For PDF files,
» when zoom in/out has been performed,

Press , ,  or  to adjust the position of the screen.

» when zoom in/out has been not performed,

Press  to go to the next page.

Press  to go to the previous page.

⑦ [OK] button

Confirm an entry or selection.

⑧ [↓↓] ADJUST button

1. In the content of the web page, move the focus down to the next clickable items.
2. Move the focus down to the next control or widget such as buttons.

⑨ [M] MUTE button

Press to turn the mute function on/off.

The button is only controlled by Scalar.

⑩ [Red] [Green] [Yellow] [Blue] COLOR buttons

1.  : No function on Android source. These two buttons are only controlled by Scalar.

2. For PDF files,

press  button to perform zoom-in;

press  button to perform zoom-out.

After zoom-in or zoom-out, press  button to revert the pdf file to the original size.

⑪ [Number/ ID SET/ ENTER] button

1. No functions for ID SET  and ENTER  on Android source. These buttons are only controlled by Scalar.

2. For PDF file, enter the page number by pressing number buttons and then press  button to jump to the specific page.

⑫ [F] FORMAT button

Change picture format. The button is only controlled by Scalar.

⑬ [↶] BACK button

Return to the previous page or exit from the previous function.

⑭ [i] INFO button

1. Display information about current input signal. It is shown by Scalar.

2. Media Player -> Compose -> edit or new add playlist -> choose any media files -> press  to show the information of the chosen media file.

⑮ [O] OPTIONS button

Open toolbox in Media Player or PDF Player:

1. Media Player -> Compose -> Edit or new add playlist -> press  to open toolbox. Toolbox will be slide from the left side of the screen.

2. PDF Player -> Compose -> Edit or new add playlist -> press  to open toolbox. Toolbox will be slide from the left side of the screen.

⑯ [V-] [V+] VOLUME button

Adjust volume. The buttons are only controlled by Scalar.

2.3.4. Inserting the batteries in the remote control

The remote control is powered by two 1.5V AAA batteries.

To install or replace batteries:

1. Press and then slide the cover to open it.
2. Align the batteries according to the (+) and (-) indications inside the battery compartment.
3. Replace the cover:

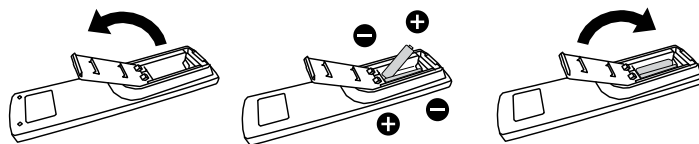

Caution:

The incorrect use of batteries can result in leaks or bursting. Be sure to follow these instructions:

- Place "AAA" batteries matching the (+) and (-) signs on each battery to the (+) and (-) signs of the battery compartment.
- Do not mix battery types.
- Do not combine new batteries with used ones. It causes shorter life or leakage of batteries.
- Remove the dead batteries immediately to prevent them from liquid leaking in the battery compartment. Don't touch exposed battery acid, as it can damage your skin.

NOTE: If you do not intend to use the remote control for a long period, remove the batteries.

2.3.5. Handling the remote control

- Do not subject to strong shock.
- Do not allow water or other liquid to splash the remote control. If the remote control gets wet, wipe it dry immediately.
- Avoid exposure to heat and steam.
- Other than to install the batteries, do not open the remote control.

2.3.6. Operating range of the remote control

Point the top of the remote control toward the display's remote control sensor when pressing a button.

Use the remote control within a distance of less than 5m/16ft from the display's sensor, and a horizontal and vertical angle of less than 30 degrees.

NOTE: The remote control may not function properly when the remote control sensor on the display is under direct sunlight or strong illumination, or when there is an obstacle in the path of signal transmission.

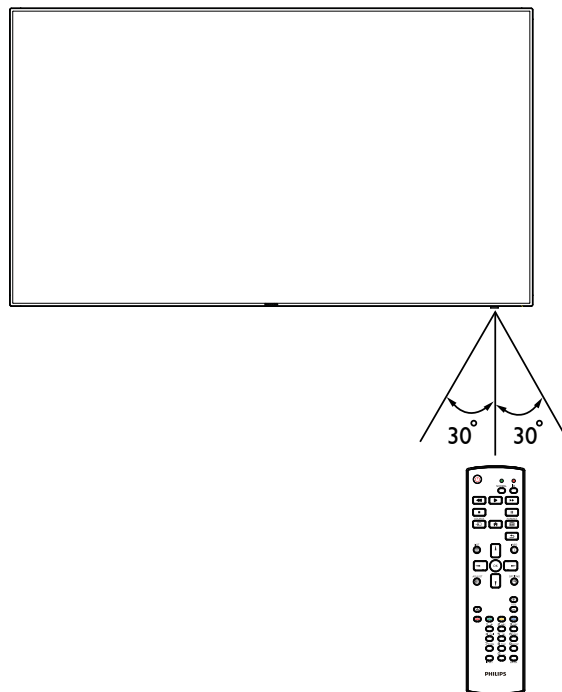

3. Connecting External Equipment

3.1. Connecting External Equipment (DVD/VCR/VCD)

3.1.1. Using HDMI video input

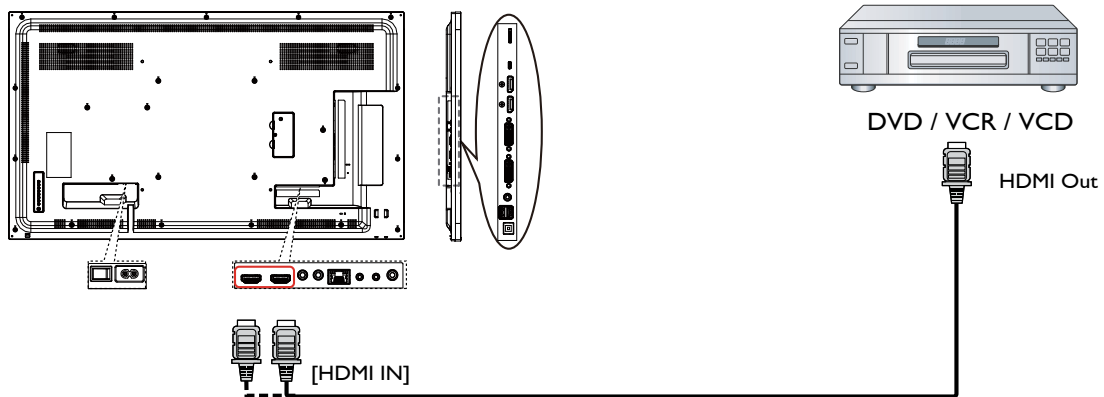

3.2. Connecting a PC

3.2.1. Using DVI-I input

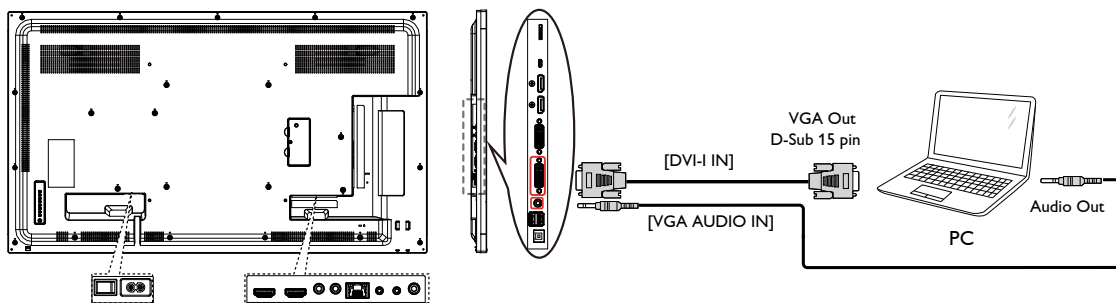

3.2.2. Using DVI input

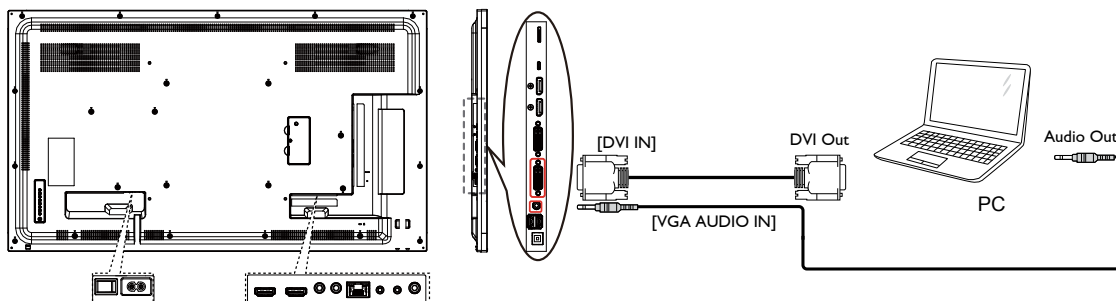

3.2.3. Using HDMI input

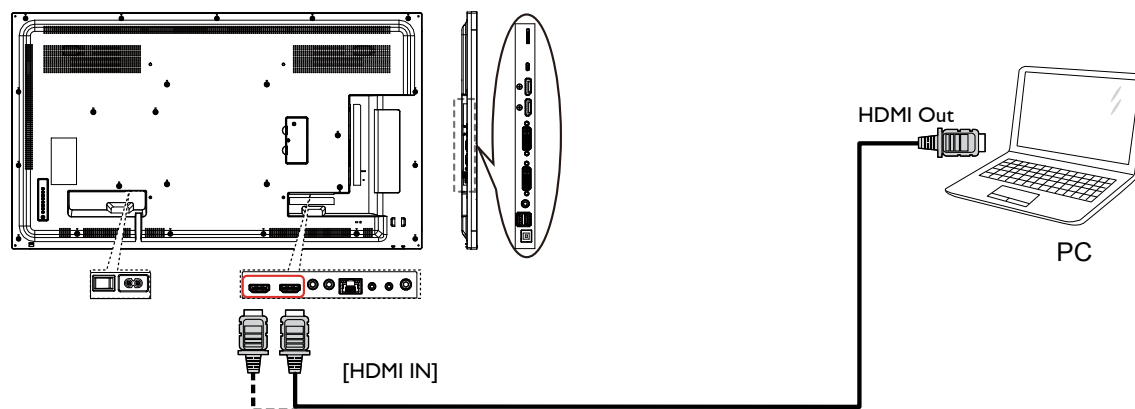

3.2.4. Using DisplayPort input

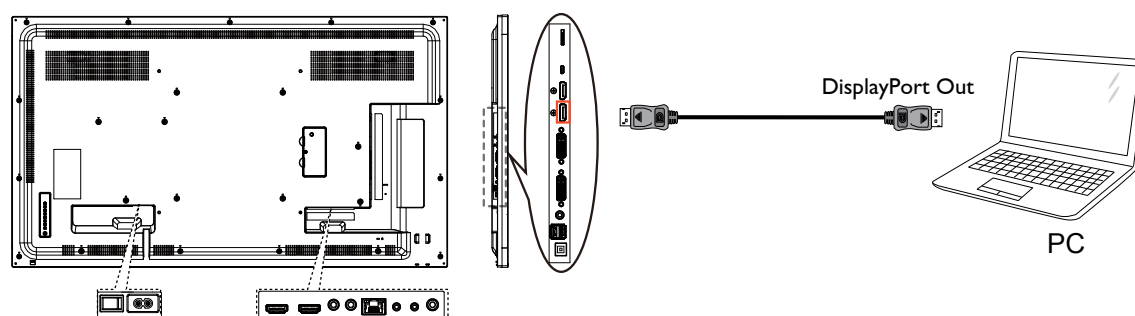

3.3. Connecting Audio Equipment

3.3.1. Connecting an external audio device

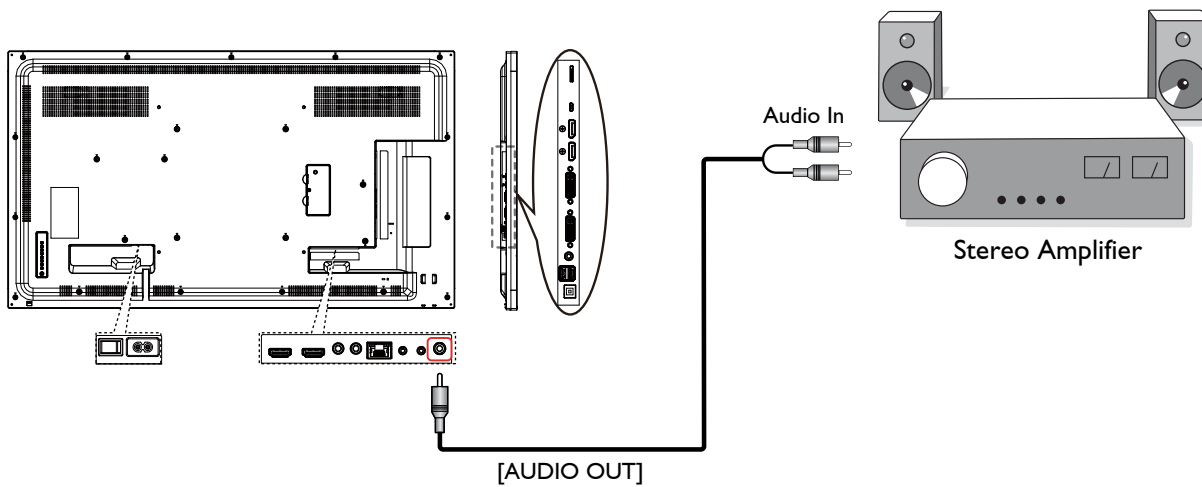

3.4. Connecting Multiple Displays in a Daisy-chain Configuration

You can interconnect multiple displays to create a daisy-chain configuration for applications such as a video wall.

NOTE: Maximum 25 displays (5x5) can be used in a DVI daisy-chain configuration. For VGA daisy-chain, Maximum 9 displays can be used.

3.4.1. Display control connection

Connect the [RS232 OUT] connector of DISPLAY 1 to the [RS232 IN] connector of DISPLAY 2.

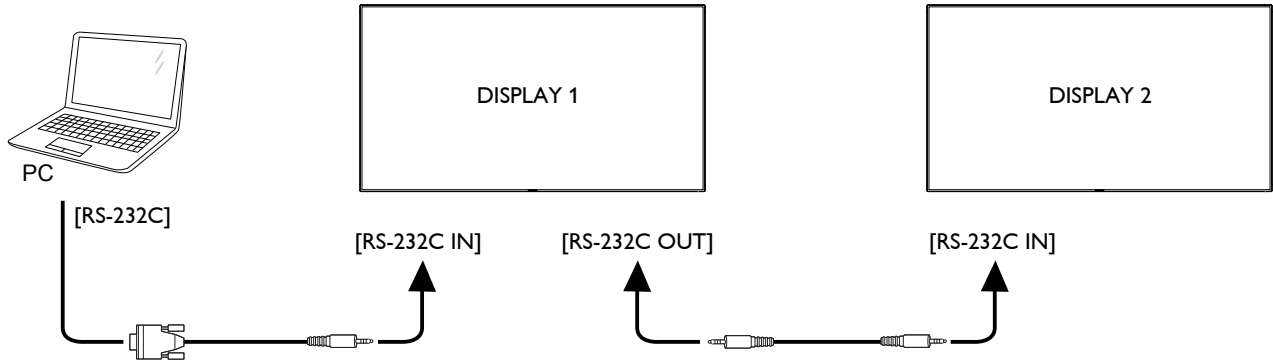

3.4.2. Digital video connection

Connect the [DVI OUT / DVI-I OUT] connector of DISPLAY 1 to the [DVI IN] connector of DISPLAY 2.

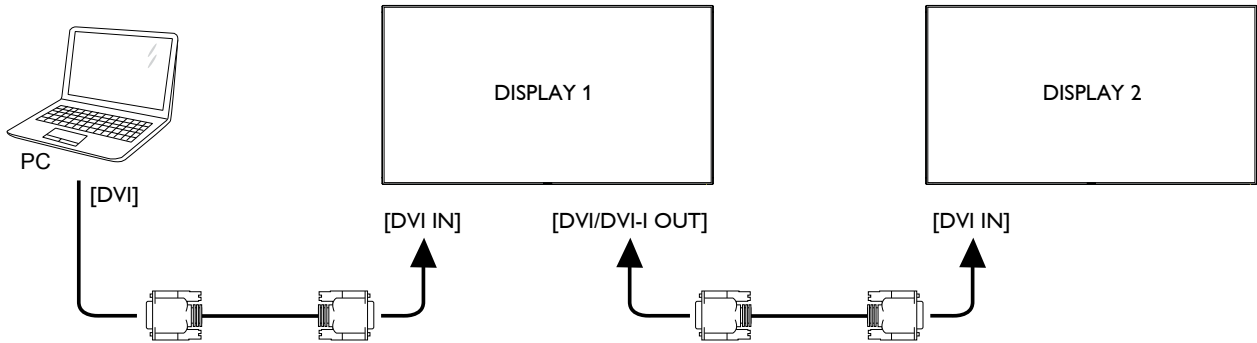

Connect the [DP OUT] connector of DISPLAY 1 to the [DP IN] connector of DISPLAY 2.

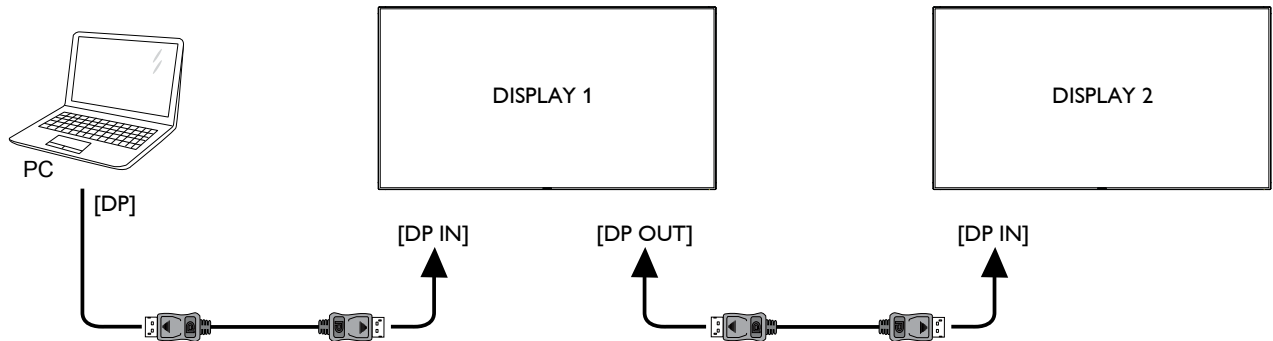

Connect the [DVI OUT] connector of DISPLAY 1 to the [DVI IN] connector of DISPLAY 2.

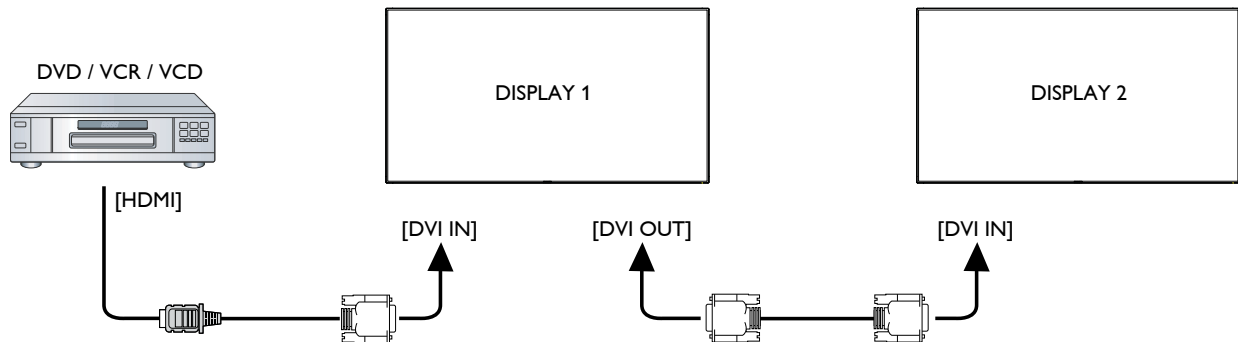

3.4.3. Analog video connection

Connect the [DVI OUT /DVI- OUT] connector of DISPLAY 1 to the [DVI-I IN] connector of DISPLAY 2.

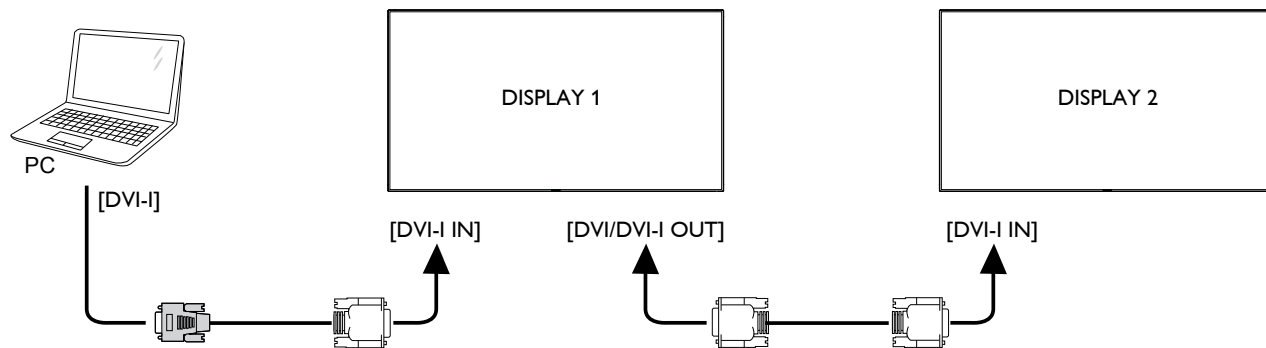

3.5. IR connection

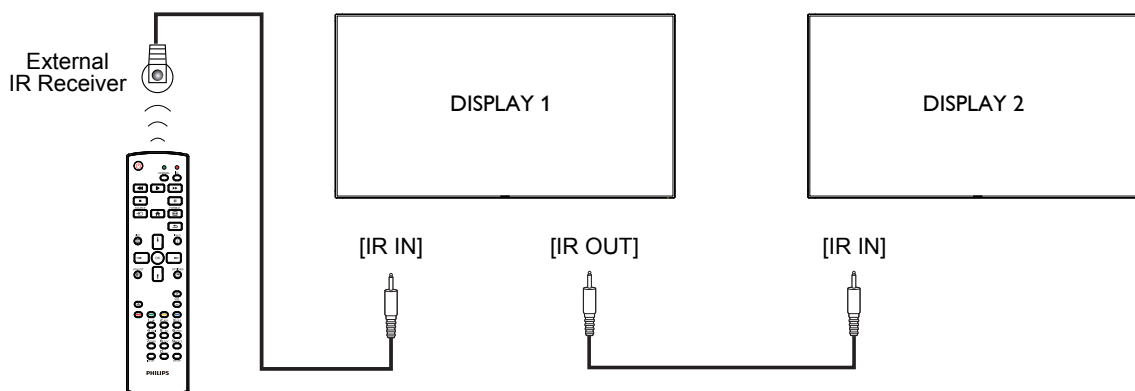

NOTE:

1. This display's remote control sensor will stop working if the [IR IN] is connected.
2. IR loop through connection can support up to 9 displays.

3.6. IR Pass-through Connection

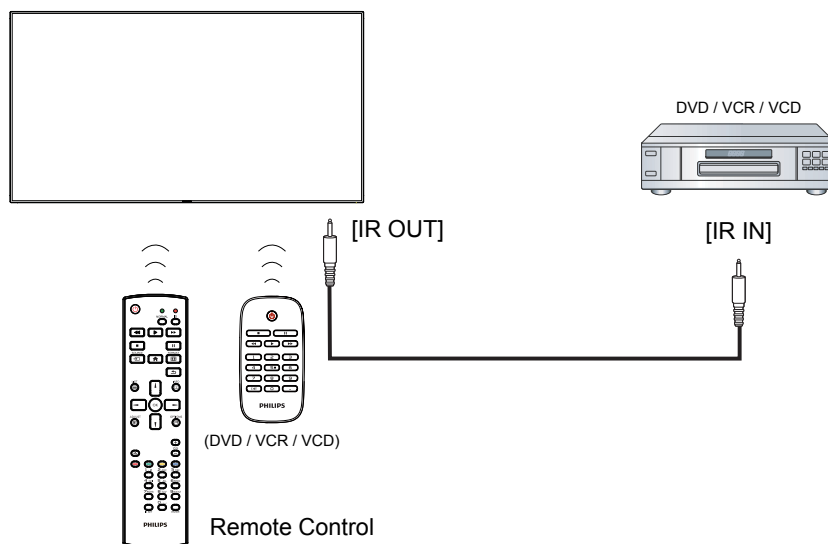

4. Operation

NOTE: The control button described in this section is mainly on the remote control unless specified otherwise.

4.1. Watch the Connected Video Source

See page 14 for external equipments connection.

1. Press **[SOURCE]** button.
2. Press **[M]** or **[T]** button to choose a device, then press **[OK]** button.

4.2. Change Picture Format

You can change the picture format to suit the video source. Each video source has its available picture formats.

The available picture formats depend on the video source:

1. Press **[FORMAT]** button.
2. Press **[M]** or **[T]** button to choose a picture format, then press **[OK]** button.
 - PC mode: {Full} / {4:3} / {1:1} / {16:9} / {21:9} / {Custom}.
 - Video mode: {Full} / {4:3} / {1:1} / {16:9} / {21:9} / {Custom}.

4.3. Android Launcher

1. Android PD launcher:
 - Android PD launcher is black page, as below:

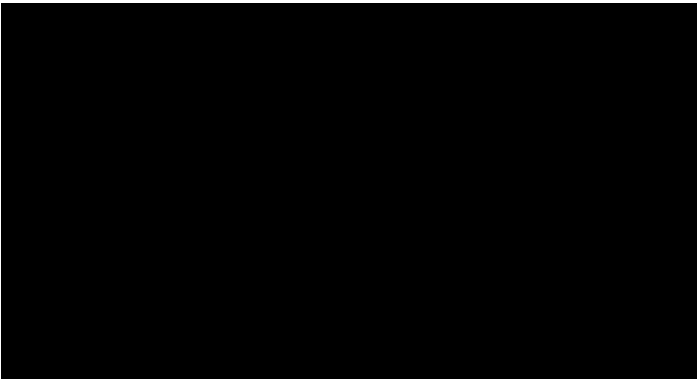

- Every app leaves by pressing the back key. The screen will go to Android PD launcher.
- When you return to android PD launcher, the screen will show hint image, The hint image only shows 5 seconds as below:
- The hint image will notify you can press source key to change source.

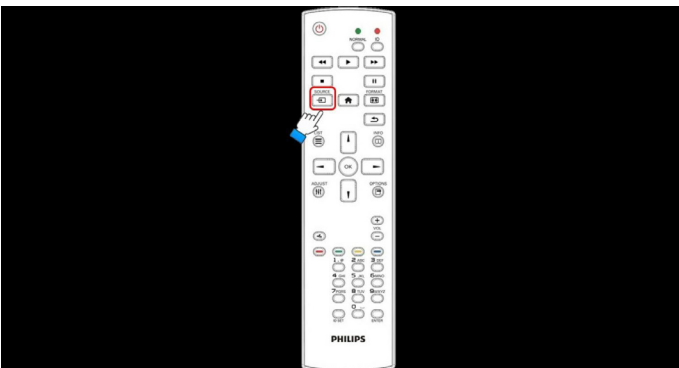

2. Admin mode:

- You can press “Home + 1888” to startup admin mode.
- Admin mode will show four icons: “Settings”, “Apps”, “Network” and “Help”.
- When you leave admin mode, system will return to last source.

1) Home page of admin mode, this page has four items: “Settings”, “Apps”, “Network” and “Help”.

Settings : go to settings app.

Applications : show all apps.

Network : set wifi or ethernet.

Help : display QRcode.

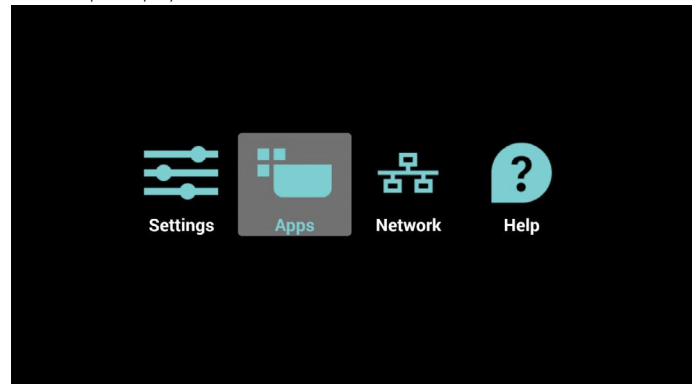

2.) Application page:

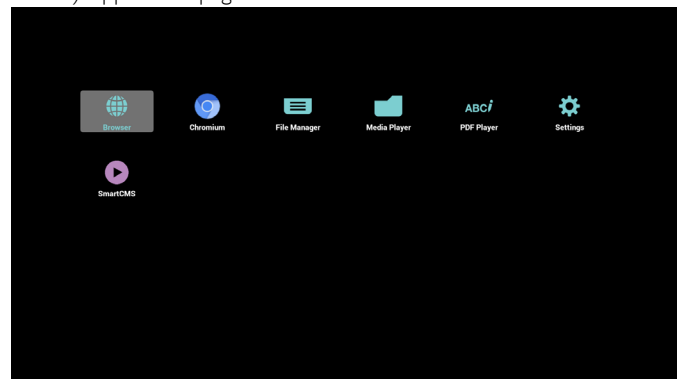

3) Network page

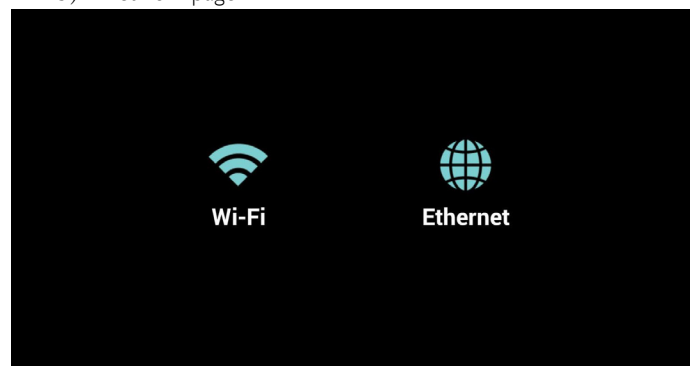

4) Wi-Fi page:



5) Ethernet page

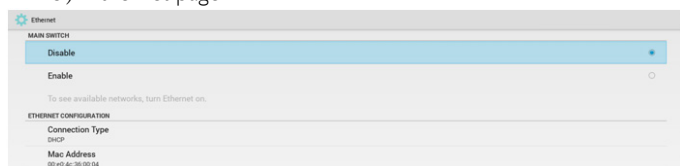

6) Help page:

Display QRcode page.



4.4. Media Player introduction:

1. Home page of Media Player; this page has three items: "Play", "Compose" and "Settings".
Play : select playlist to play.
Compose: edit playlist.
Settings: setting play properties.

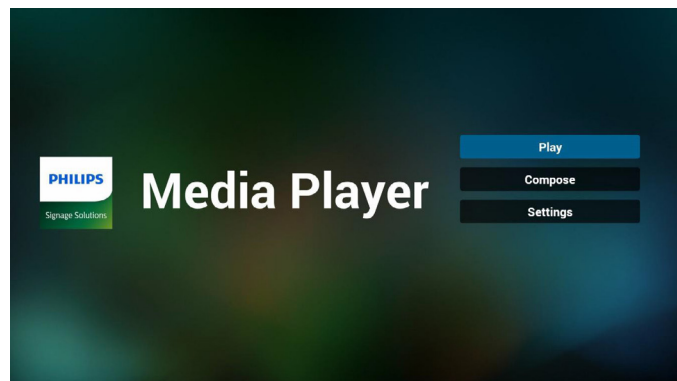

2. Select "Play" on home page, first you should choose one playlist to play between FILE 1 and FILE 7.
The pencil icon means the playlist is non-empty.

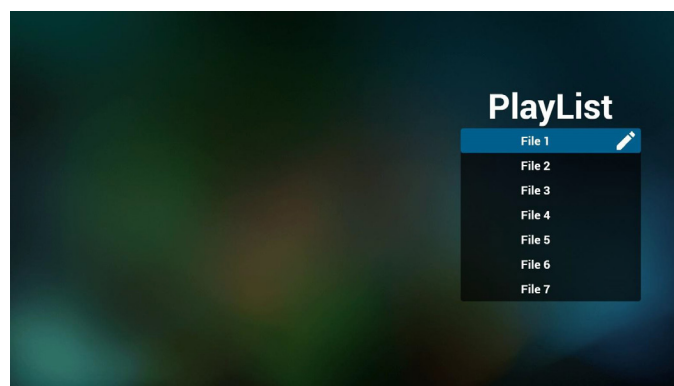

3. Select "Compose" on home page, first you should choose one playlist to edit between FILE 1 and FILE 7.
The pencil icon means the playlist is non-empty.

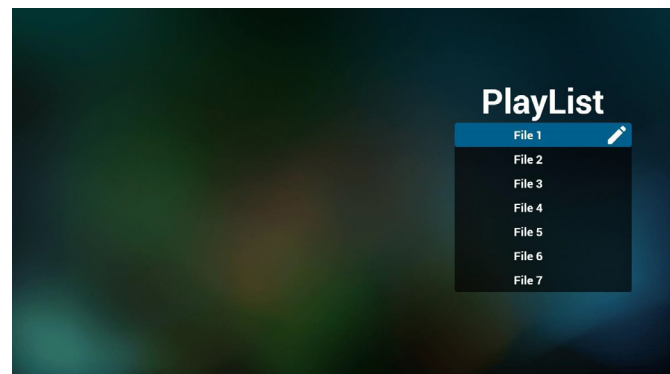

4. If an empty playlist is chosen, the app will guide you to select the media source.
All media files should be placed in /philips/ of root directory.
For example,
- videos in /root/philips/video/
- photos in /root/philips/photo/
- music in /root/philips/music/

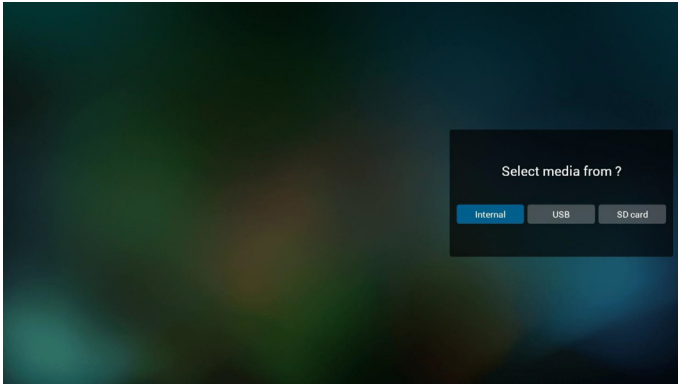

5. You could edit or delete a non-empty playlist, just choose the desired playlist which is with pencil icon.

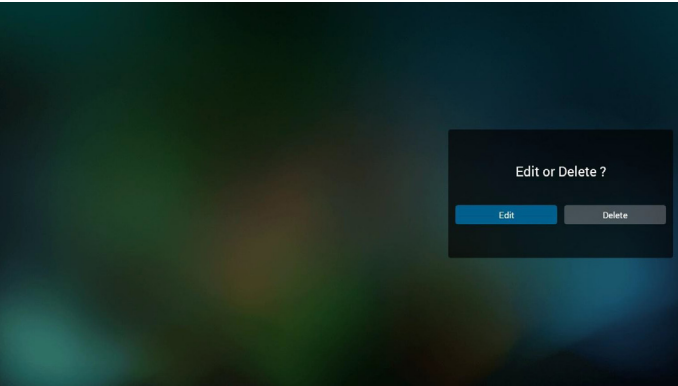

6. Once you start to edit a playlist, you will see below screen.
 Source - files in storage.
 Playlist – files in playlist.
 There are 4 icons which map to the keys of remote controller:
 Option key – launch slide bar
 Play key – play media file.
 Info key – show media info.
 Ok key – select/unselect file.

6-1 In the slide bar, it helps you to do the following:

- select all : select all storage files.
- delete all : delete all playlist files.
- add/remove : update playlist from source.
- sort : sort playlist.
- save/abort : save or abort playlist.
- back : return.

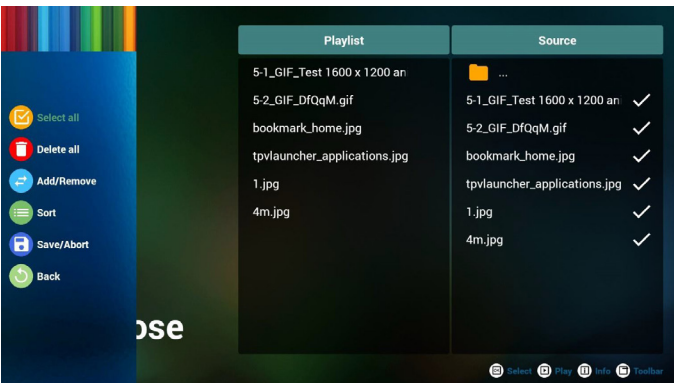

7. if you choose "Sort" in the slide bar, you can change the order of files one by one.

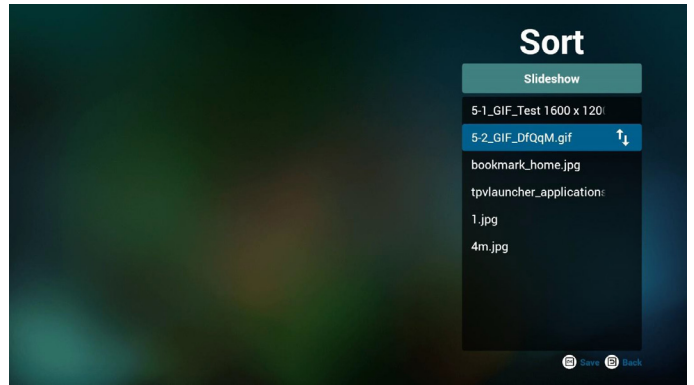

8. Press info key after you choose desired file, you will get the detail information.

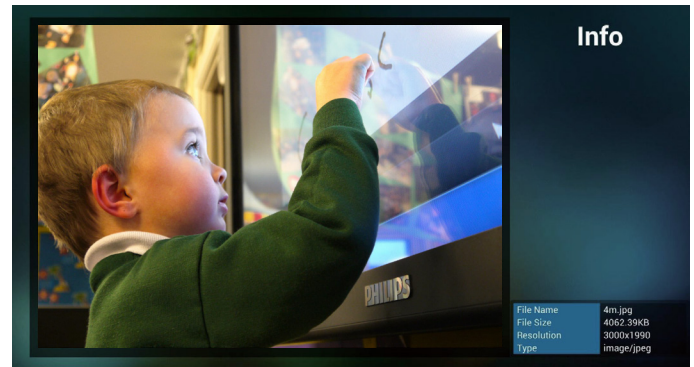

9. Press play key after you choose desired file, you will plays the media file directly.



10. If you make a playlist with all images files, before saving, the app will ask you if you want to have background music while playing slideshow.

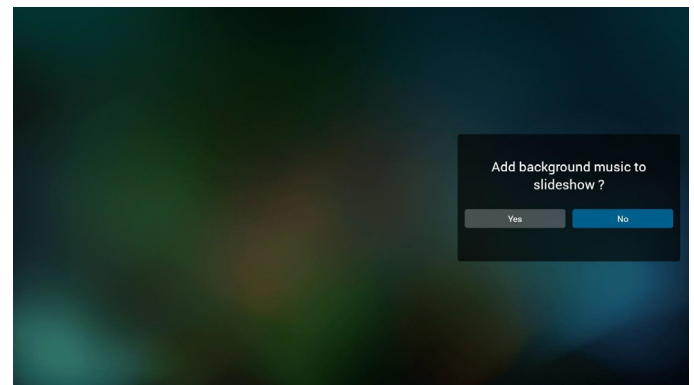

11. Select "Settings" on home page, this page has three parts, "Repeat Mode", "Slideshow Effect" and "Effect Duration".

Repeat Mode : play mode.

Slideshow Effect : photo slideshow effect.

Effect Duration : photo effect duration.

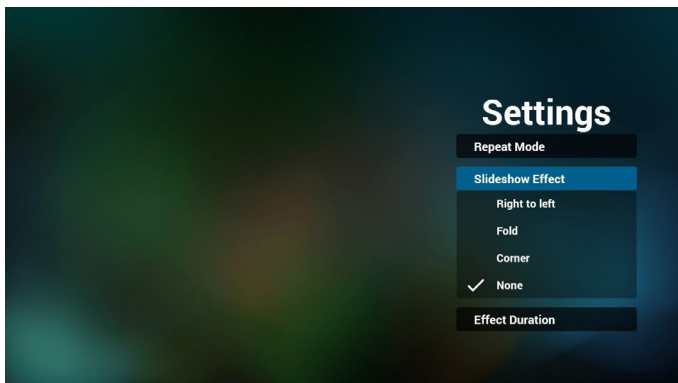

12. Media Hotkey

Play : Playback file.

Pause: Pause file.

Fast forward: forward 10 second.

Rewind: back 10 second.

Stop: Stop file and return to start.If the gif file, it like the pause.

4.5. Browser manual

1. Home page of Browser app, this page has one item: "Settings". Press Settings then enter next page.

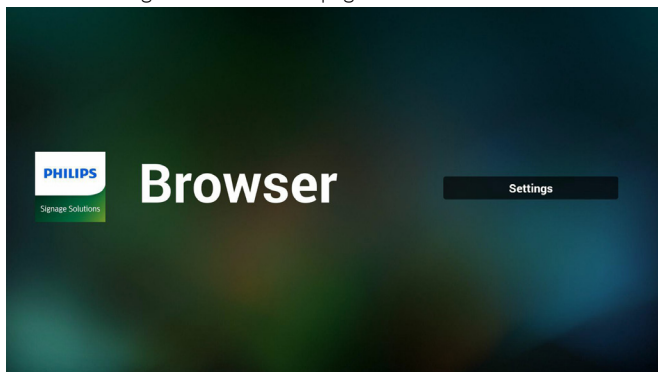

2. Users can choose 1~7.

Press any one will show a dialog.

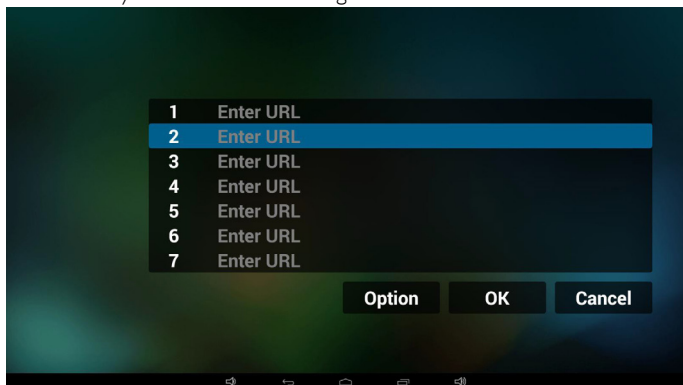

3. Enter url and press OK then data will save on List

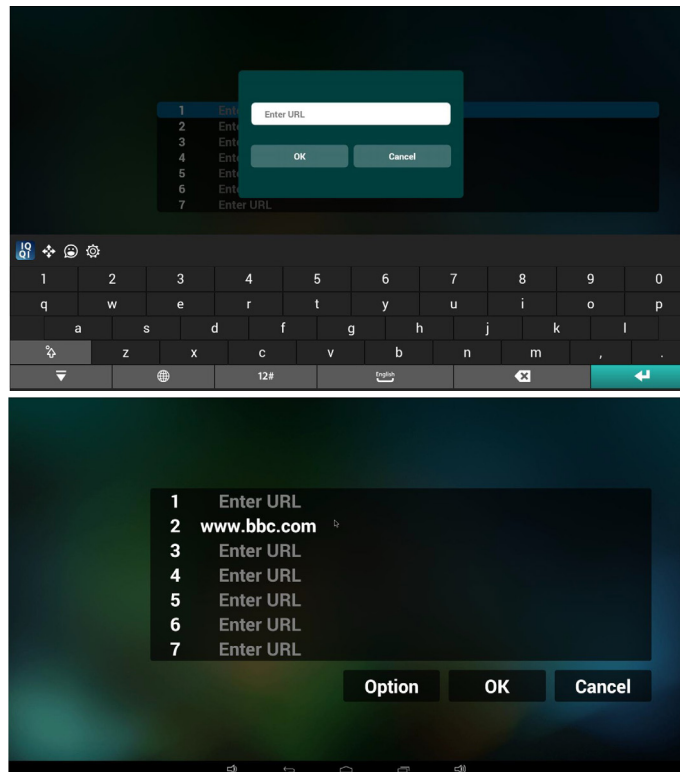

4. Press "Option" then left side will pop up a list
 Import : Import url list file
 Export : Export url list file
 Delete all : Delete all url record on right side
 Back : left side list will be closed.

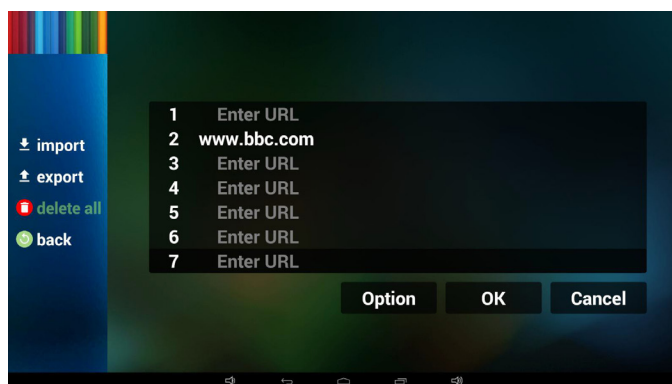

4.1 Import

- Click import

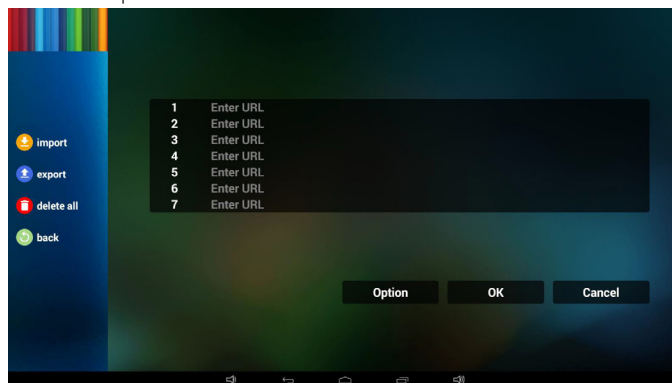

- Choose storage

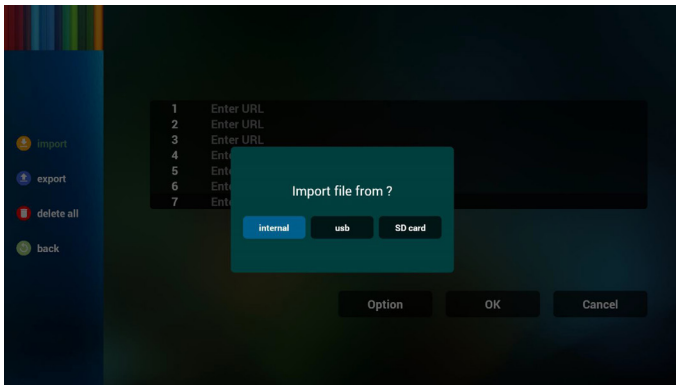

- Choose file contains urls

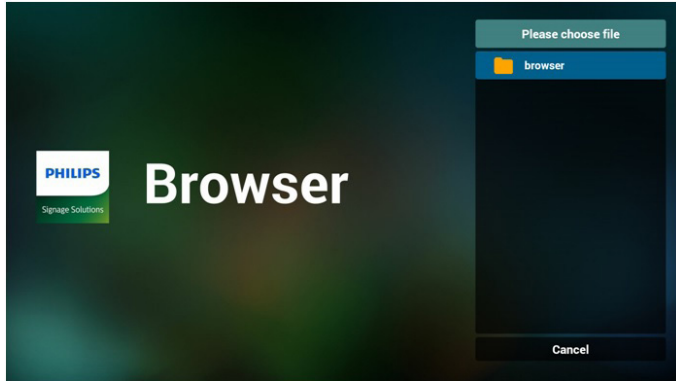

- Import file and url will show on list

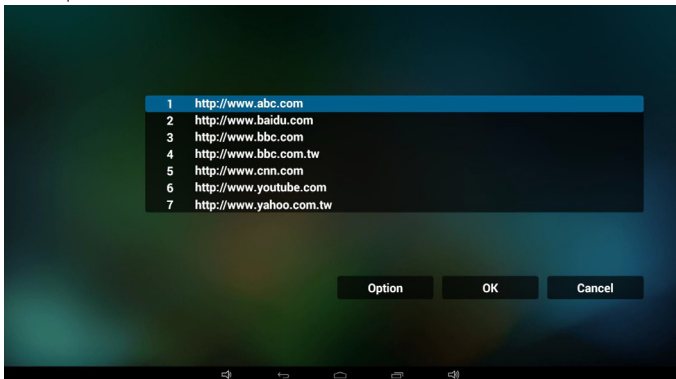

- File format for import
Format should be like below with file extension "txt"

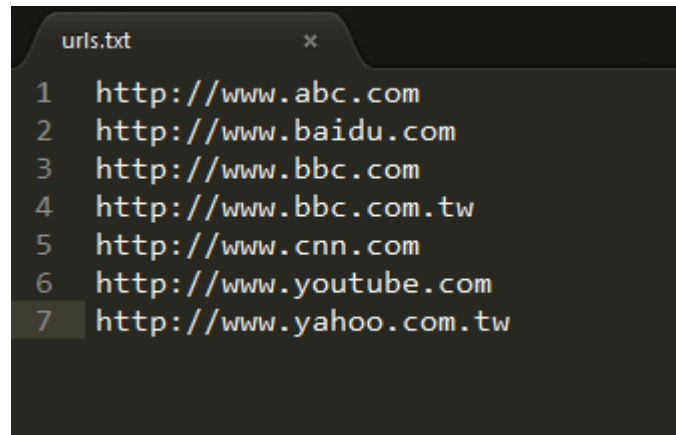

4.2 Export:

- Click export

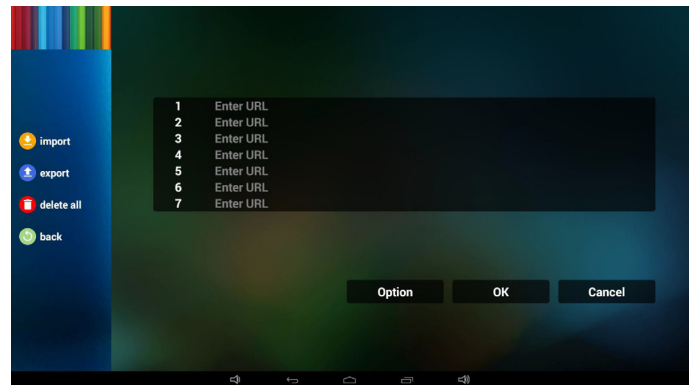

- Choose storage

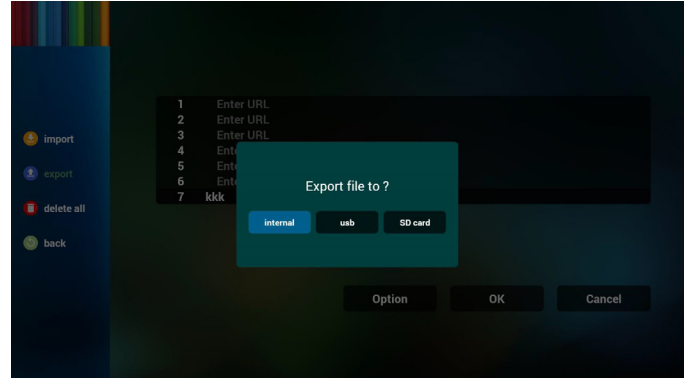

- Dialog shows path file will be saved and file's name.
Press "save" button then urls on list will be saved.

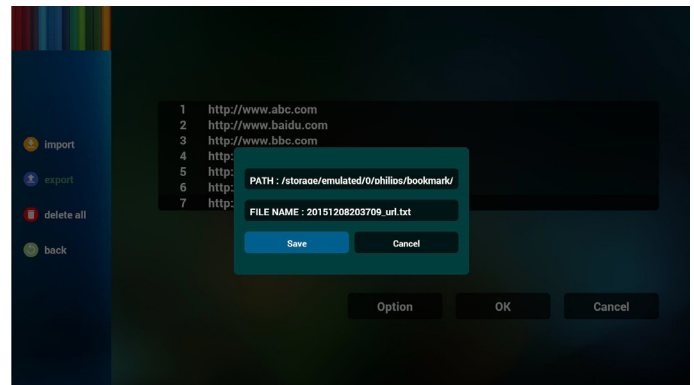

- 5. Press OK then url records will be saved.

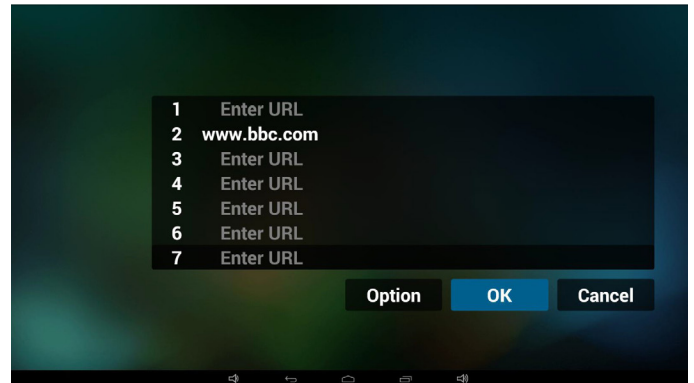

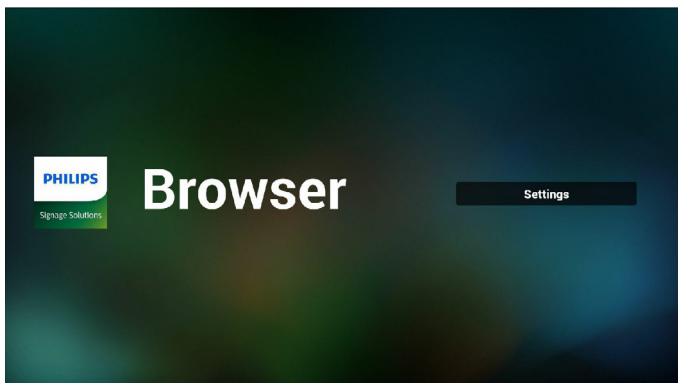

6. On url list page, if you select non-empty item, it will show a dialog to ask edit or play url. If press "Edit", it will show edit url dialog, if press "Play", it will show web page of item's url.

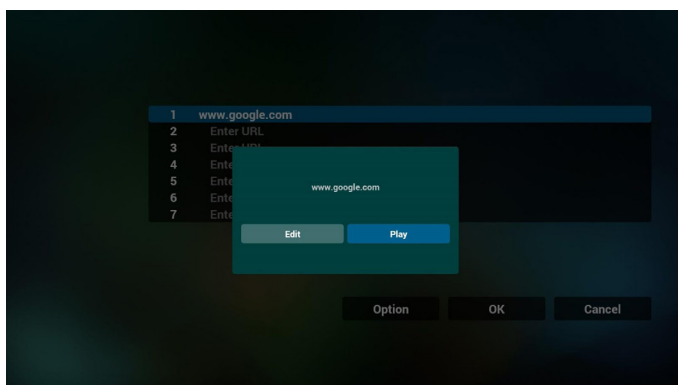
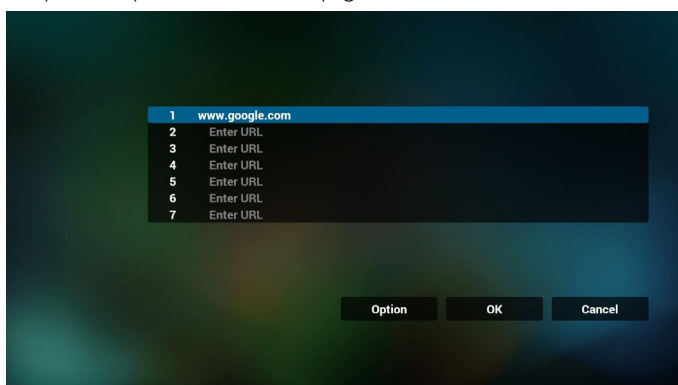

7. OSD menu interaction with Browser

7.1 Boot on source

- Set OSD menu => Configuration1 => Boot on source => Input be BROWER Play List be 0.
Then PD will show Browser after reboot.
- Set OSD menu => Configuration1 => Boot on source => Input be BROWER Play List be 1.
Then PD will show web page with 1st Url in Browser app.

7.2 Schedule

Set OSD menu => Advanced option => Schedule =>
On time1, Off time2, Input be BROWSER, any day you want of week,
and Play List.

Finally check the right box.

Then PD will show web page with Url in Browser app at time1 and finish at time2.

4.6. PDF reader play

1. Home page of PDF Player, this page has three items: "Play", "Compose" and "Settings".

Play : select playlist to play.

Compose: edit playlist.

Settings: setting play properties.

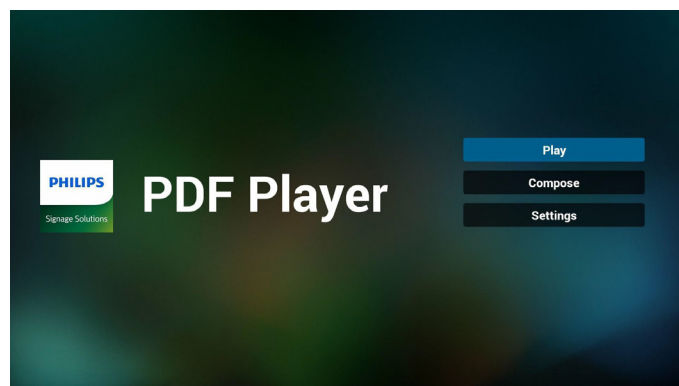

2. Select "Play" on home page, first you should choose one playlist to play between FILE 1 and FILE 7.

The pencil icon means the playlist is non-empty.

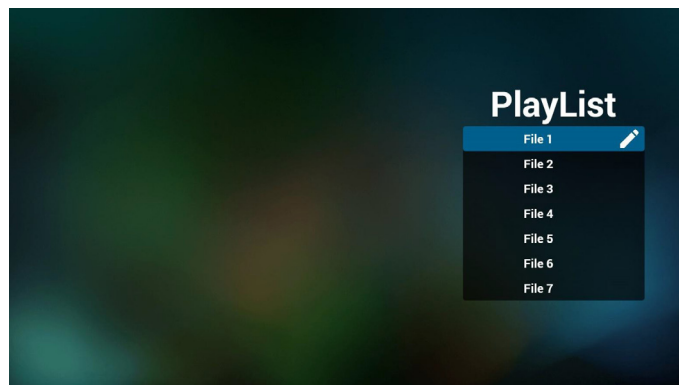

3. Select "Compose" on home page, first you should choose one playlist to edit between FILE 1 and FILE 7.

The pencil icon means the playlist is non-empty.

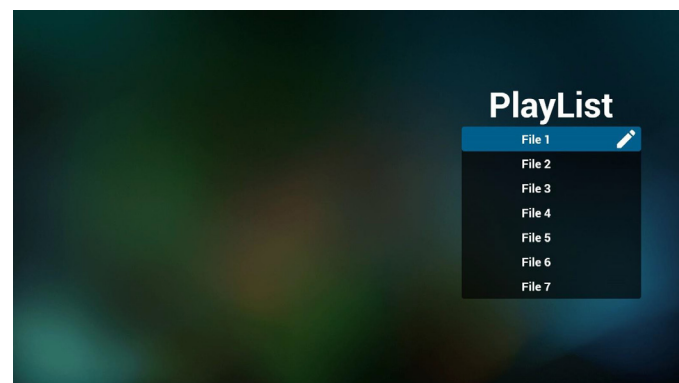

4. If an empty playlist is chosen, the app will guide you to select the media source.

All media files should be placed in /philips/ of root directory. For example,

- pdfs in /root/philips/pdf/

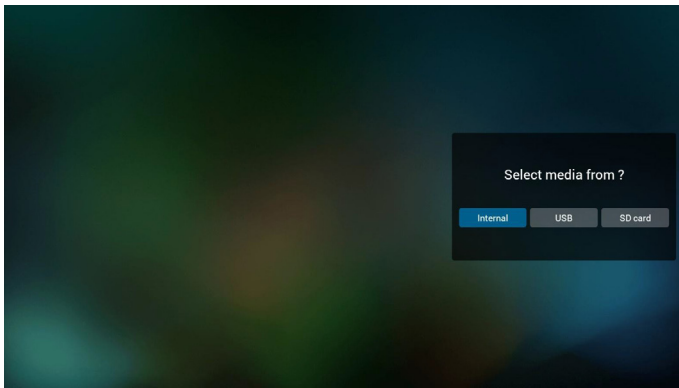

5. You could edit or delete a non-empty playlist, just choose the desired playlist which is with pencil icon.

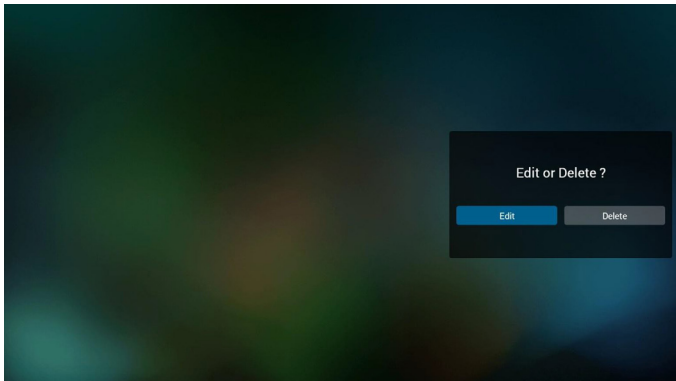

6. Once you start to edit a playlist, you will see below screen.
- Source - files in storage.
 Playlist – files in playlist.
- There are 4 icons which map to the keys of remote controller:
 Option key – launch slide bar
 Play key – play media file.
 Info key – show media info.
 Ok key – select/unselect file.

6-1. In the slide bar, it helps you to do the following:

- select all : select all storage files.
- delete all : delete all playlist files.
- add/remove : update playlist from source.
- sort : sort playlist.
- save/abort : save or abort playlist.
- back : return.

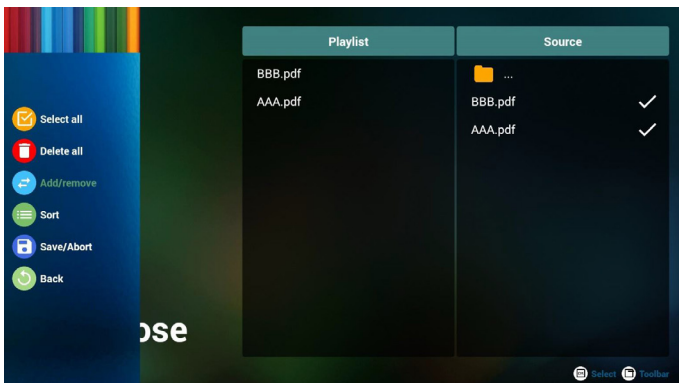

7. if you choose “Sort” in the slide bar, you can change the order of files one by one.

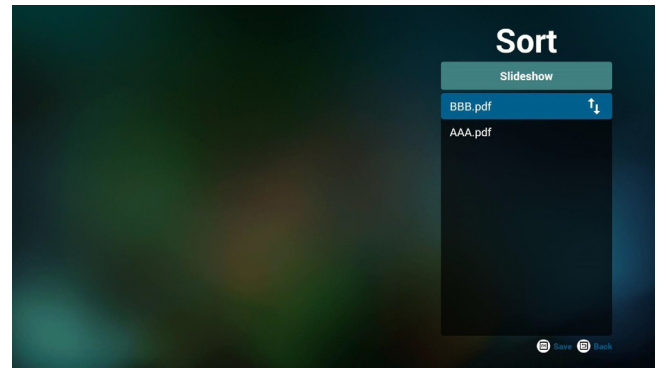

8. Select “Settings” on home page, this page has two parts, “Repeat Mode” and “Effect Duration”.

Repeat Mode : play mode.

Effect Duration : photo effect duration.

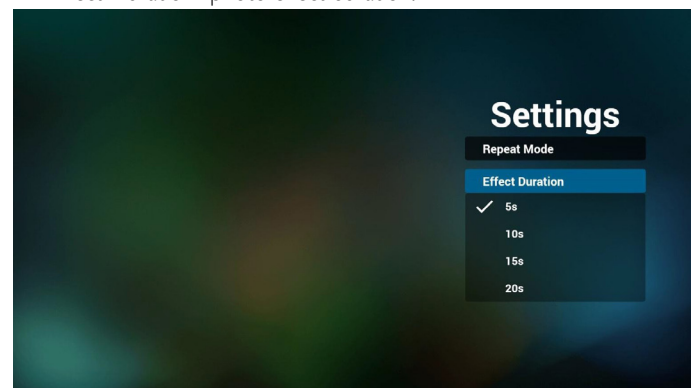

Media Hotkey:

Play : Playback file.

Pause: Pause page.

Fast forward: go to next page, if the page is end of the file, it will go to next file.

Rewind: back to last page, if the page is first of the file, it will back to last file.

Stop: return to first page of file

Color Hotkey:

Blue : Zoom in.(+10%)

Yellow : Zoom out.(−10%)

OK : Restore zoom

Arrow keys:

Up/Down/Left/Right : Adjust page. (When the page has zoomed in/out)

Left : Previous Page. (When the page has not zoomed in/out)

Right : Next Page. (When the page has not zoomed in/out)

Combination key:

Number key + OK key : select specific page, and press ok key to change page.

- Press number key.



2016 © Koninklijke Philips N.V. All rights reserved.

Philips and the Philips Shield Emblem are registered trademarks of Koninklijke Philips N.V. and are used under license from Koninklijke Philips N.V.

Specifications are subject to change without notice.

55BDL4050D
V1.00



www.philips.com/welcome
User Manual (English)

PHILIPS
SignageSolutions

- Press OK key, the bottom of the page will show the page number, if page number over total page number, it will not change page and show current page number at the bottom of the page.

4.7. SmartCMS

1. Settings

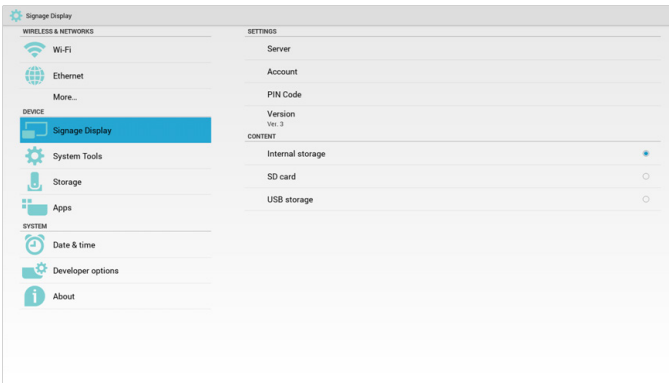
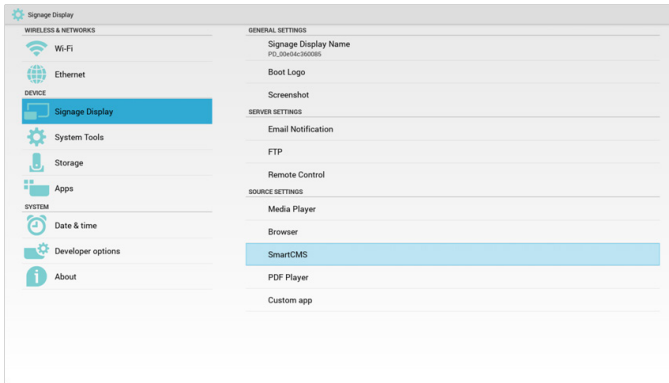

- 1) Server IP:Your_SmartCMS_server_address
 - 2) Account: admin
 - 3) PIN Code: 0281(Default, which can be generate by server tool)
 - 4) Version:Ver. 3 (default value)
- You can select Ver. 2 or Ver. 3. And SmartCMS would download cms contents from a Ver. 2 server or a Ver. 3 server:
- a.Ver. 3:You need to set server information (ip, account, PIN Code) in the settings.
 - b.Ver. 2:You need to install cms data from local storage for the first time. And server information would be accessed from the local cms content.The options in the settings, including IP, account, and PIN Code, would be disabled.
- 5) Content: cms content can be stored in the internal storage, SD card, and USB storage. By default, the target is internal.
- a. If server is connected, cms data would be downloaded from SmartCMS server.
 - b. If server is disconnected, cms data would be accessed from local storage.
- 6) Local cms content (*.cms file)
- a. If content is set to be internal storage, *.cms should be stored in the FTP root folder(high priority) or /sdcard/philips(low priority).
 - b. If content is set to be USB storage or SD card, *.cms should be stored in the root folder of external storage.

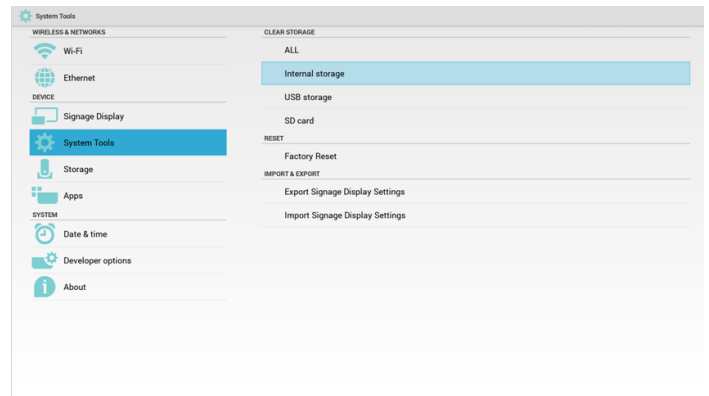

7) You can delete cms data via System Tools.

2. Set source to SmartCMS, cms data will be downloaded automatically

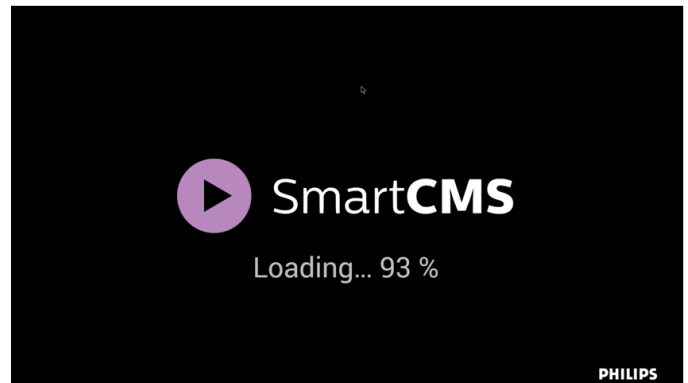

- 1) If there is no cms data in the server or the network is disconnect. "No Content" will be shown.
- 2) If you select "SD card" or "USB storage", "No Content" will be shown when you remove the SD card/USB storage.

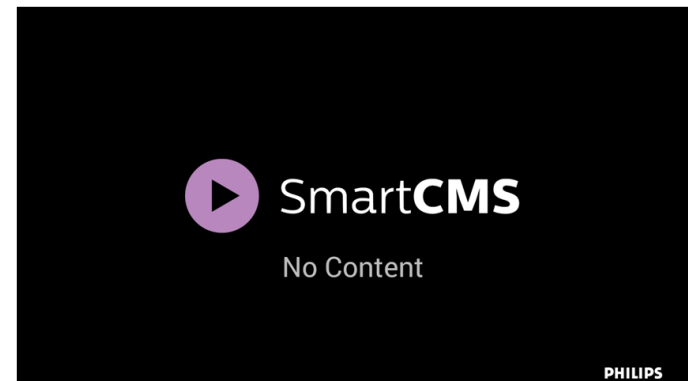

4.8. Custom app

User can set up the application for Customer Source

Note:

- (1) Only display User Installed app.
- (2) Will not show up system pre-install app.

4.8.1. OSD Menu operation:

RCU: Source -> Custom

If set up customer APK, PD will open customer app when switch source to Customer mode.

If no set up customer APK, PD will show Black screen when switch source to Customer mode.

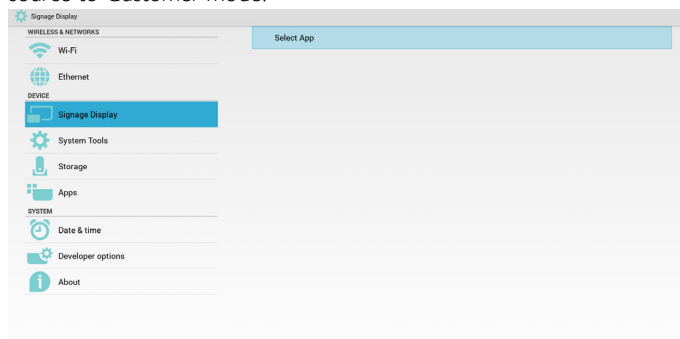

4.8.2. Function Introduction

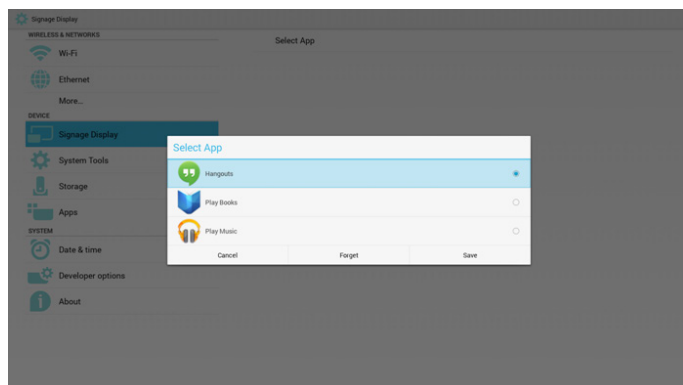

Save

Select the App, click the Save will perform the function of storage.

Forget

After press the Forget, can remove previously stored information.

Cancel

Don't do any change, directly closed Windows.

If no customer installed apk, the list will be blank.

The list will be blank and "Save""Forget" will be gray and useless.

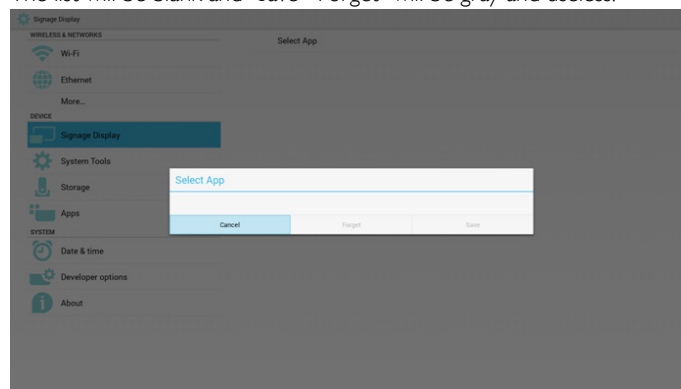

If customer installed apk,user can select customer installed apk in list

- Case 1: Not set up Custom App case.
Customer app will show up and focus on first item automatically.

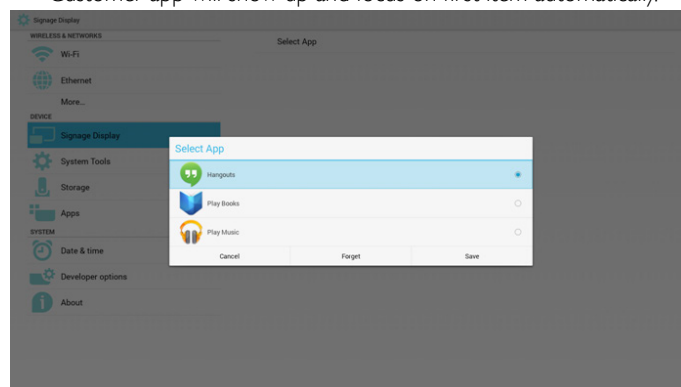

After set up, the setting screen display the app name.

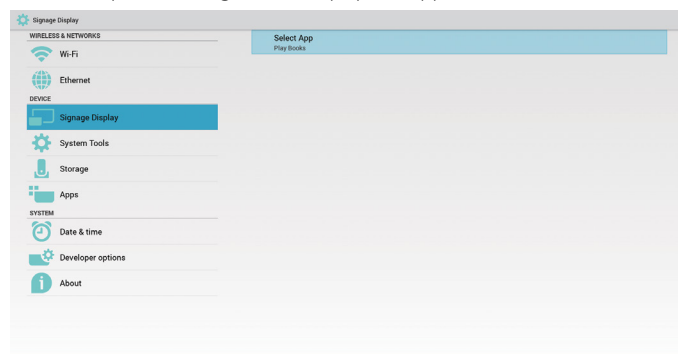

- Case 2: Set up Custom App case(there is entity circle to the right of icon)

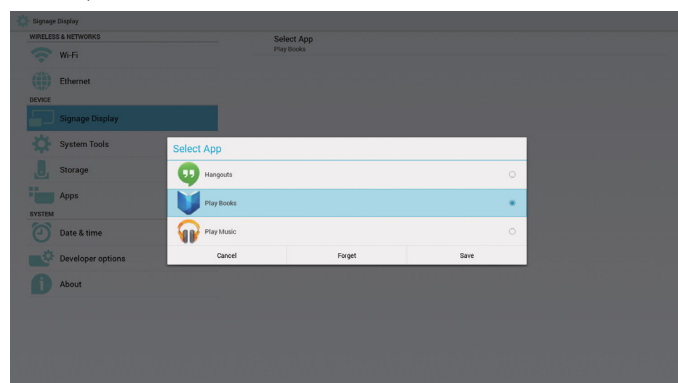

5. signage display

5.1. Setting

Setting main items:

- (1) Wi-Fi
- (2) Ethernet
- (3) Signage Display
- (4) System Tools
- (5) Storage
- (6) Apps
- (7) Date & time
- (8) Developer options
- (9) About

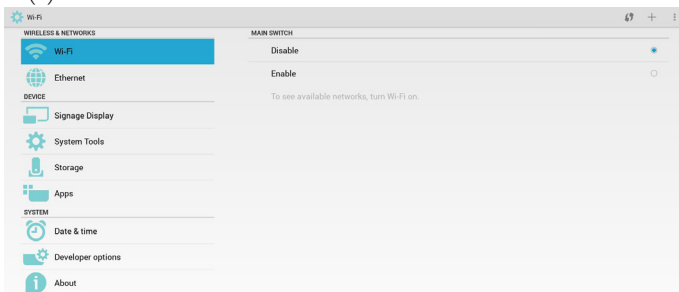

5.2. Wi-Fi

Via Enable/Disable to control Wi-Fi On/OFF. After Enable, the screen will list all available WiFi AP.

Note :

Ethernet will be disable automatically if Wifi turn on and connect to network.

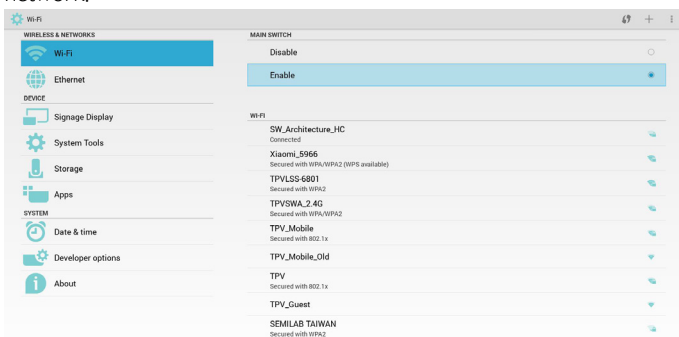

5.3. Ethernet

Via Enable/Disable to control Ethernet On/Off. After enable Ethernet, it will display:

- (1) Connect Type (available type is DHCP/Static IP)
 - A. DHCP
 - B. Static IP
 - C. IP Address
 - D. Netmask
 - E. DNS Address

F. Gateway Address

(2) Mac Address

Note:

WiFi will be disable automatically if Ethernet turn on and connect to network.

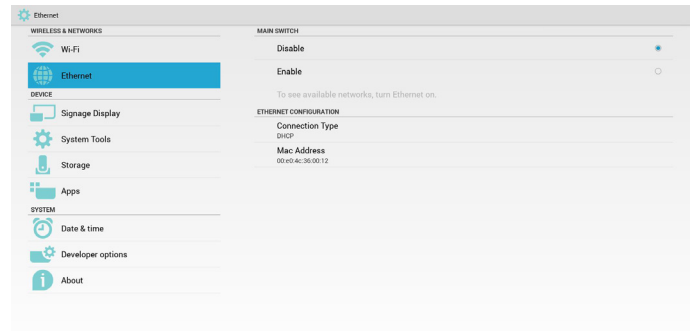

5.3.1. DHCP

DHCP mode:

- (1) Cannot modify IP Address, Netmask, DNS Address and Gateway.
- (2) (If connect successfully, it will display current network configuration.

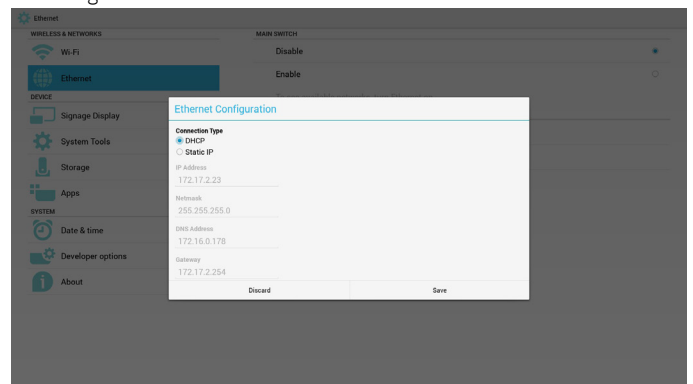

5.3.2. Static IP

Under StaticIP, User can manually input IP Address, Netmask, DNS Address and Gateway.

Note:

IP address, netmask, DNS address and gateway address input limitation

- (1)Format:
 - I. number 0-9
 - II. decimal point "'

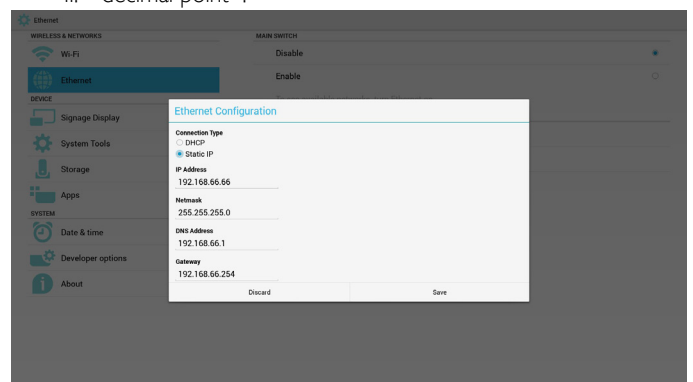

5.4. Signage Display

Divide into 3 groups: General Settings / Server Settings / Source Settings

- (1) General Settings
 - A. Signage Display Name
 - B. Boot Logo
 - C. Screenshot
- (2) Server Settings
 - A. Email Notification
 - B. FTP
 - C. Remote Control
- (3) Source Settings
 - A. Media Player
 - B. Browser
 - C. SmartCMS
 - D. PDF Player
 - E. Custom app

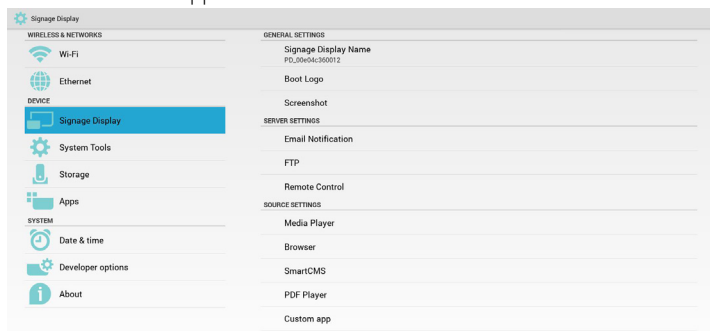

(2) Will pop-up a window for user to select USB and SD card. No priority issue.

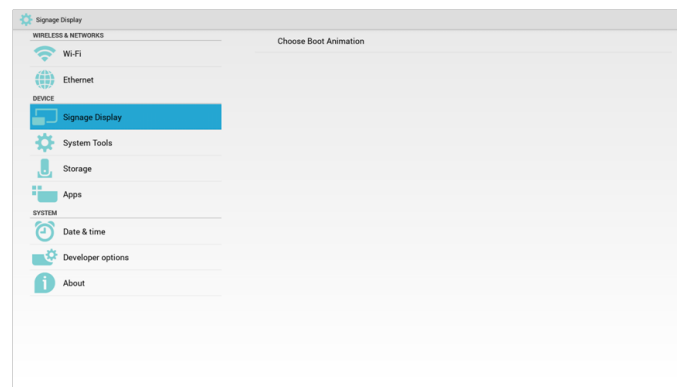

2) When boot logo selection, PD will check if there is bootanimation.zip under USB and SD card.

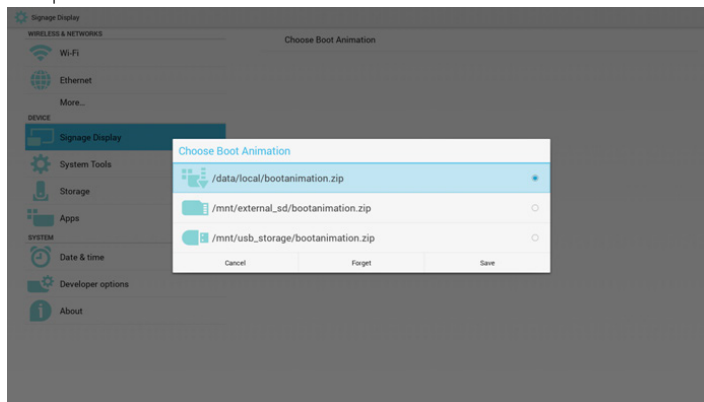

5.4.1. General Settings

1. Signage Display Name

Set up PD name "PD_" + Ethernet Mac Address.

Note:

Input limitation:

- (1) length: Max 36 characters
- (2) format: no limit

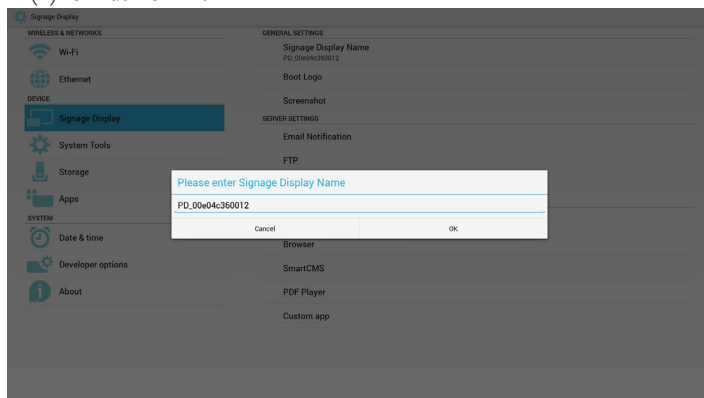

2. Boot Logo

1) Scalar OSD menu to control Android boot logo enable/disable.

Scalar OSD Menu operation:

RCU:Home -> Configuration2 -> Logo -> On/Off/User

In User mode, user can choose their own boot logo animation file.

Note:

- (1) Boot animation file name must be: bootanimation.zip

Function introduction:

a. Option description

/data/local

Use customized boot animation file which is copied from SD card or USB

/mnt/external_sd

Use boot animation file under SD card

/mnt/usb_storage

Use boot animation file under USB

b. Save

Press Save key to save SD card or USB bootanimation.zip to /data/local and set it as boot logo.

c. Forget

Press Forget key to delete /data/local bootanimation.zip and not show boot logo.

d. Cancel

Close dialogue w/o changes.

Scenario introduction:

Case 1

The users do not settle customized boot logo. PD does not find any bootanimation.zip file under SD and USB. The List will be blank. Save and Forget button will be gray and useless.

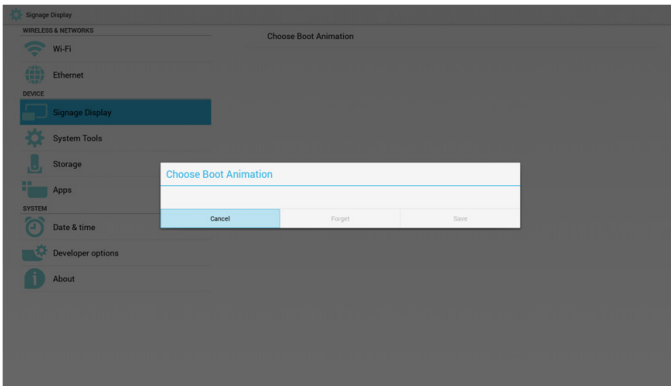

Case 2

The users do not settle customized boot log, PD find bootanimation.zip file under SD or USB. The screen will show bootanimation.zip and select the first file automatically.

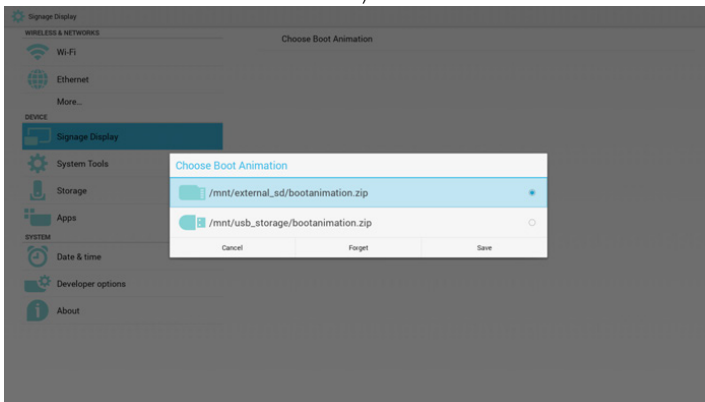

Case 3

The user settle customized boot logo, The screen will show /data/local/bootanimation.zip

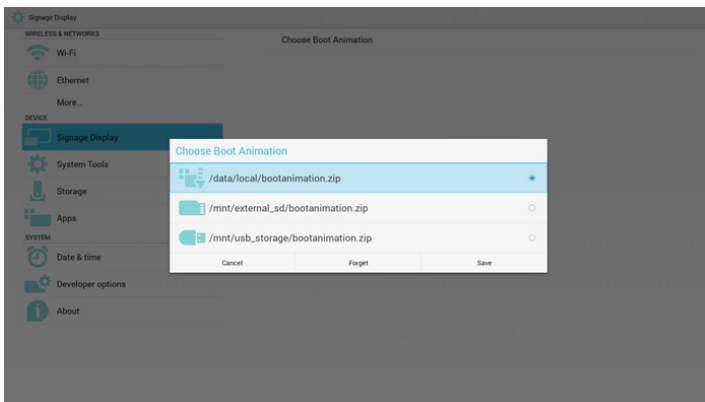

3) If OSD menu Logo item is On or Off, the users cannot choose boot animation in Android settings.

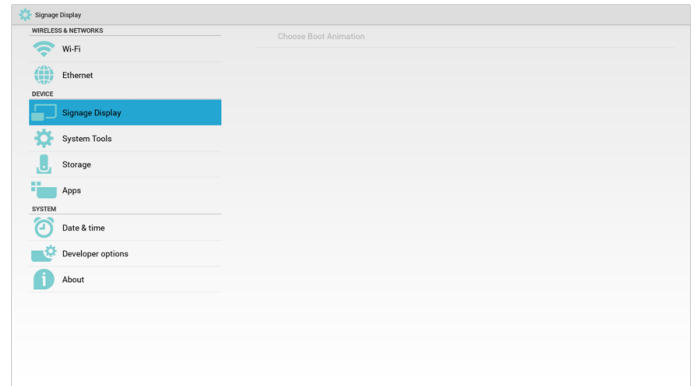

3. Screenshot

Via Enable/Disable to control screenshot On/Off. After Enable, user can set screenshot timeslot and save path.

Note:

Time slot of deletion and screenshot:

- (1) Will delete picture at initial time 0 sec.
- (2) Will screenshot at first 40 sec.

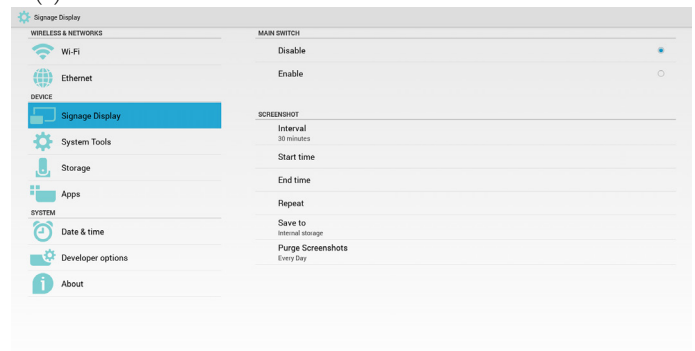

1) Interval

Set up interval timeframe. 30 mins or 60 mins.

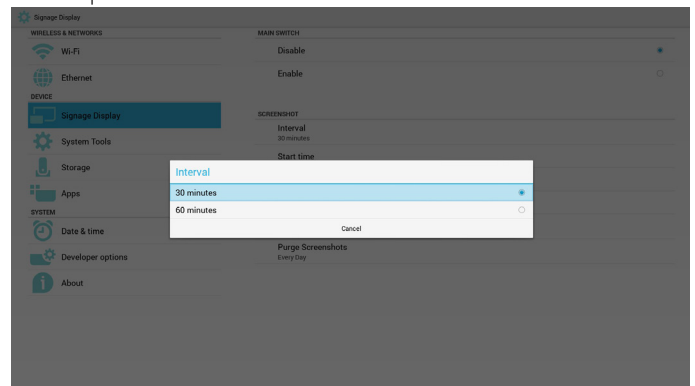

2) Start Time

Set up screenshot start time.

Note:

- (1) No Cancel, Confirm button in dialog.
- (2) Just press Back key to exit dialog for Set up
- (3) Start time cannot be newer than End time. It will show Error toast.

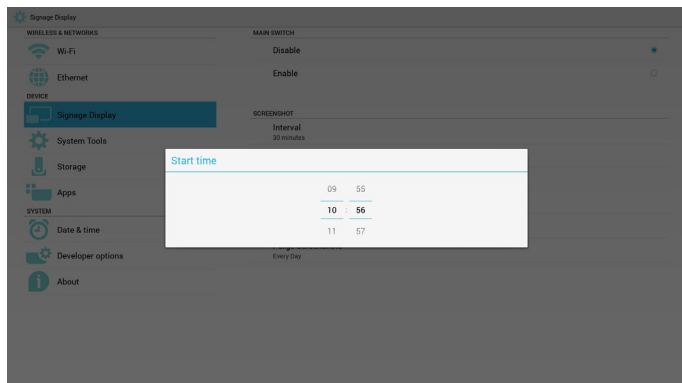

3) End Time

Set up screenshot End time

Note :

- (1) No Cancel, Confirm button in dialog.
- (2) Just press Back key to exit dialog for set up
- (3) (Start time cannot be newer than End time. It will show error toast.

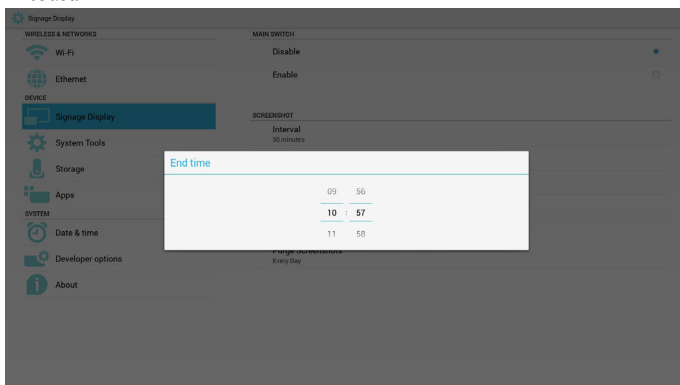

4)Repeat

Set screenshot repeat cycle. User can choose screenshot time frame. (Multiple selection)

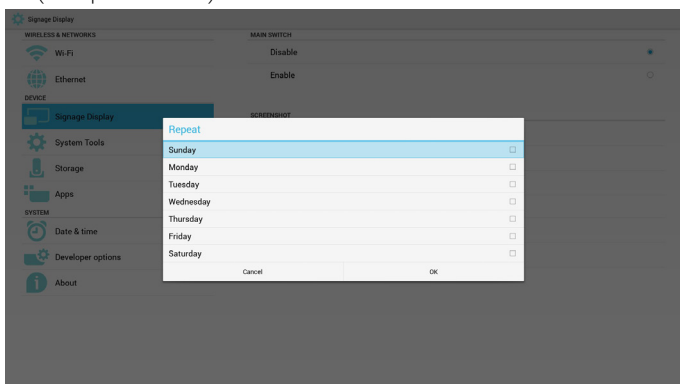

5)Save to

Set up screenshot save path. Internal storage, SD card or USB storage.

Note:

picture storage path:

- (1) In root of internal storage/usb storage/sd card, PD will create folder automatically.
- (2) the picture will save to philips/Screenshot/.

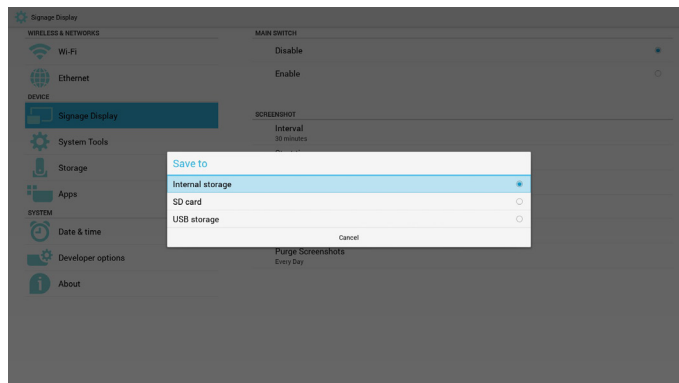

6)Purge Screenshots

Set up purge timeframe. One day or One week.

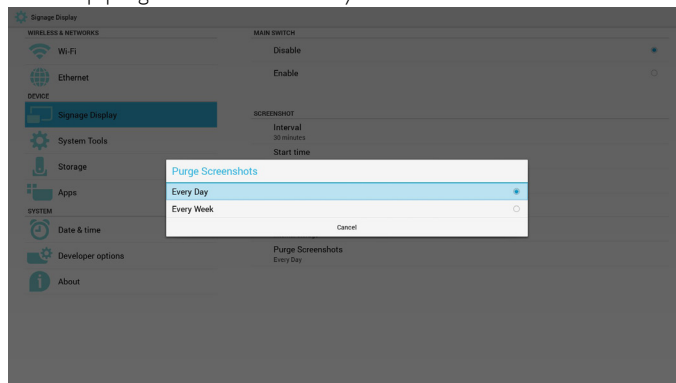

5.4.2. Server Settings

1. Email Notification

Via Enable/Disable to control Email On/Off.After Enable, user can set up Email notification configuration.

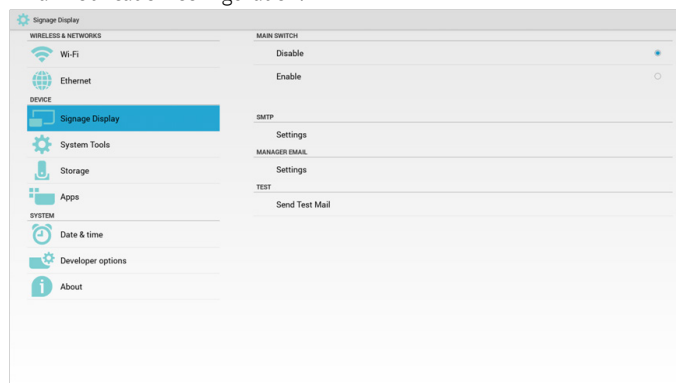

1) SMTP

Email

Set SMTP configuration.User can set Gmail account or other mail account.User can select other mail account and set up SMTP server, Security type and port itme

Note:

Password input limitation

- (1) Length: 6-20 characters
- (2) Format: no limit
- (3) Do not use the port: 5000

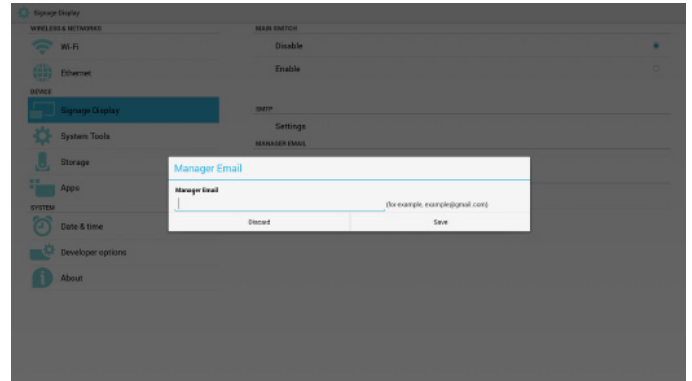
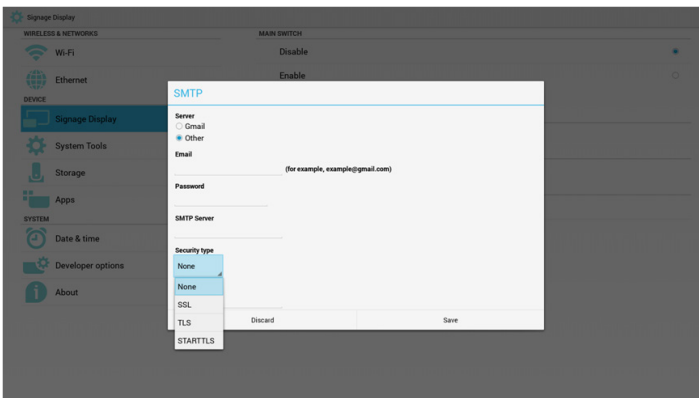
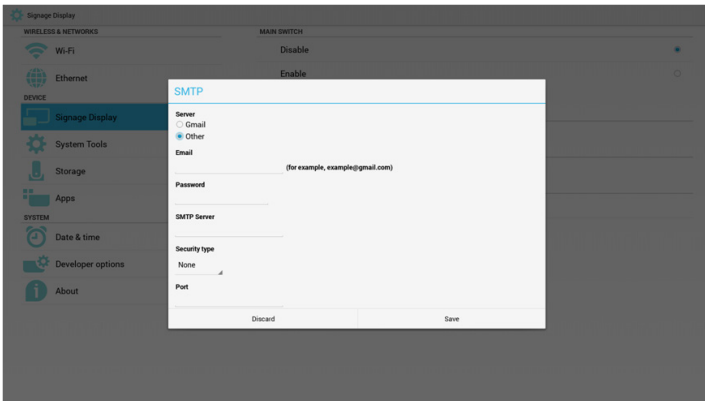
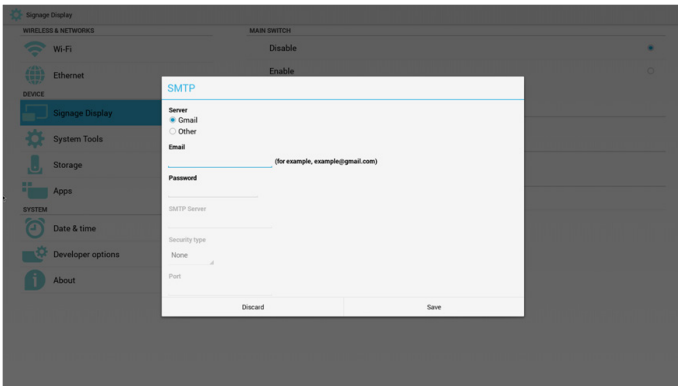

3)Test

Send Test Mail

To test Gmail account receive/send function.

2. FTP

Via Enable/Disable to control FTP On/Off. After set up, PD can share FTP files.

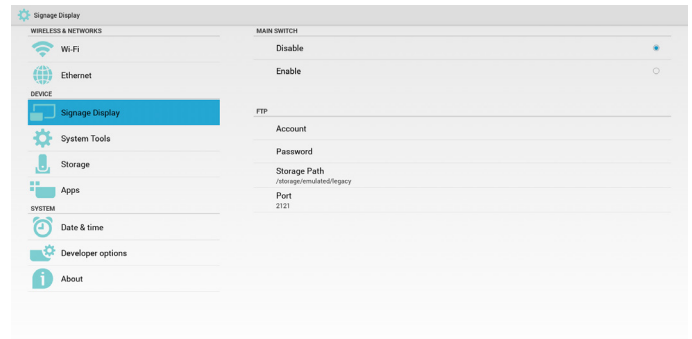

1) Account

Set up FTP account

Note:

Input limitation

- (1) Length: 4-20 characters
- (2) Format:
 - I. English a-z and A-Z
 - II. Number 0-9

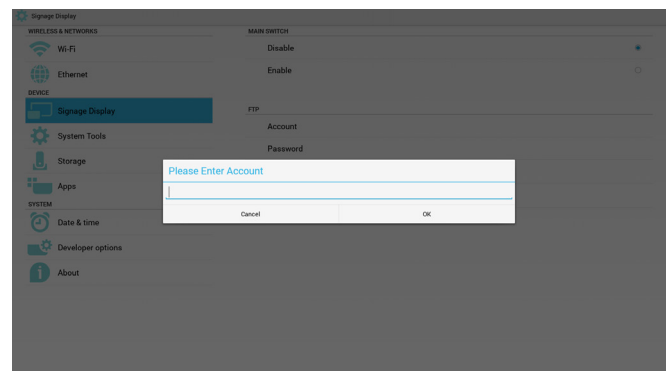

2) Password

Set up FTP password.

Note:

Input limitation

- (1) Length: 6-20 characters
- (2) Format:
 - I. English a-z and A-Z

Gmail safety setting

If it can not send manager after setting Gmail, please login your Gmail test account, then access to website:

<https://www.google.com/settings/security/lesssecureapps>.

Confirm the "Access for less secure apps", please set to Turn on

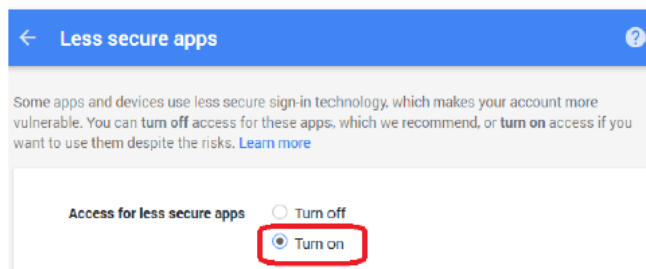

2) Manager Email

Email

Set up Receiver mail account

II. Number 0-9

FTP password display

- (1) Will show “*” symbol to instead password if set up passwork via remote control.
- (2) After set up, the password text will show as “*” symbol. Before password input:

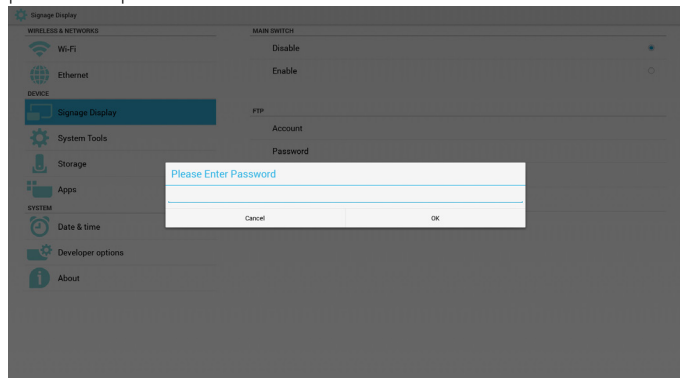

After password input:

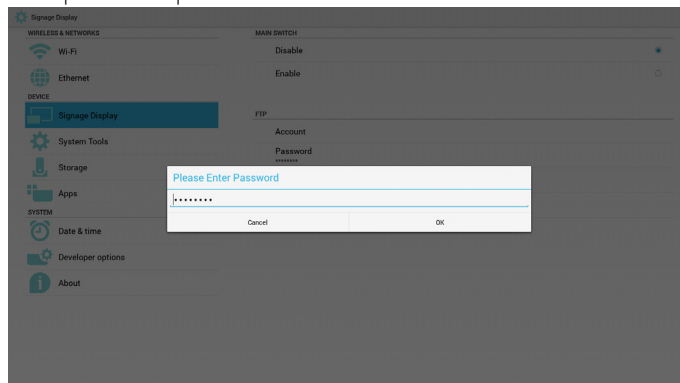

Set up completed screen:

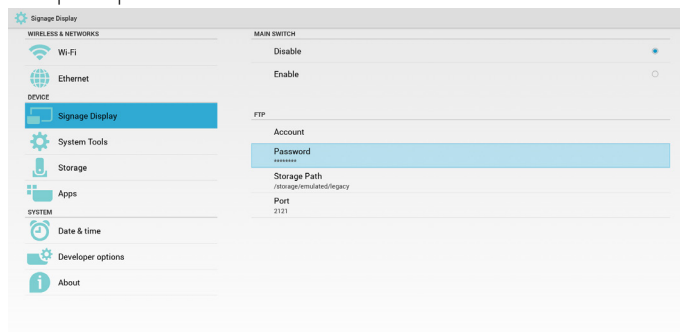

3)Storage Path

Set up FTP share path:./storage/emulated/legacy

Note:

Input limitation

- (1) Cannot save if the path is invalid

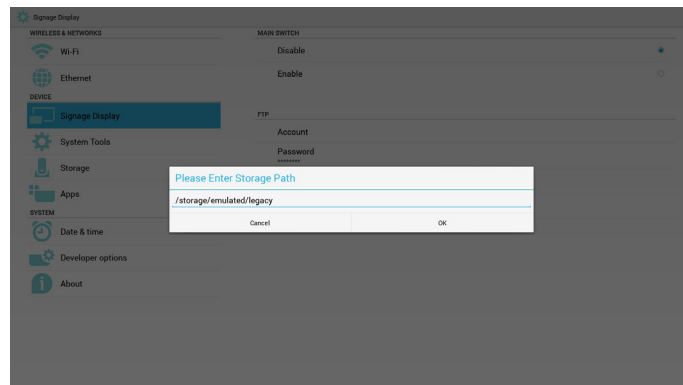

4) Port

Set up FTP port number:Default: 2121

Note:

Input limitation

- (1) Length: Max 5 characters
- (2) Range: 1-65535
- (3) Format:
 - I. Number 0-9
- (4) Do not use the port: 5000

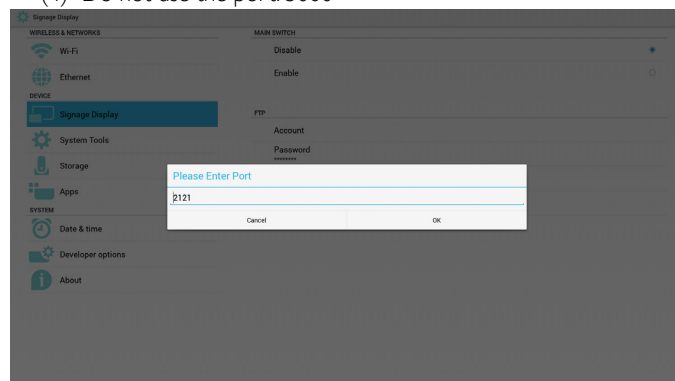

3. Remote Control

Via Enable/Disable to Control Remote Control On/Off

User can input Server address. If server does not registered, it will ask user for PIN code.

Bind status:

- (1) Will show network is disconnected if not yet connects to network.

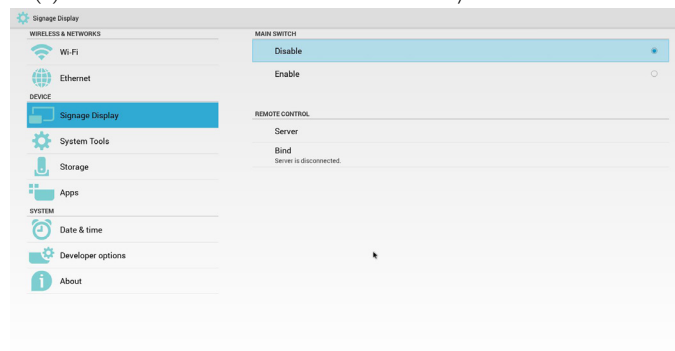

Bind status:

- (2) Will show Server is disconnected if network connected but remote control server disconnected.

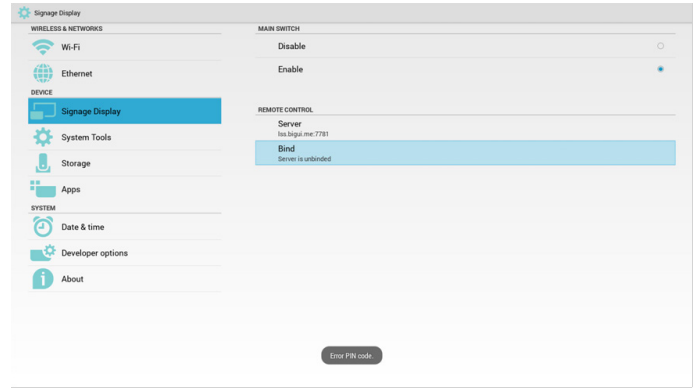
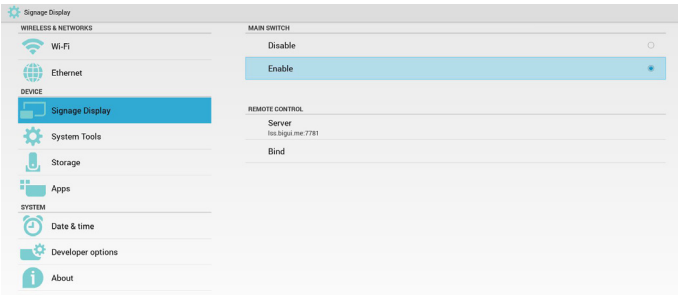

5.4.3. Source Settings

1. Media Player

Can Edit Media Player play list and effect settings.

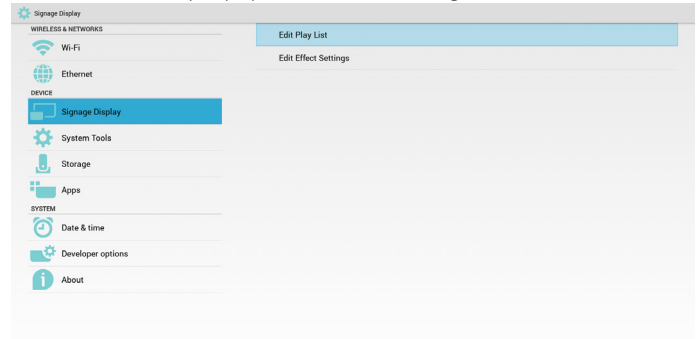
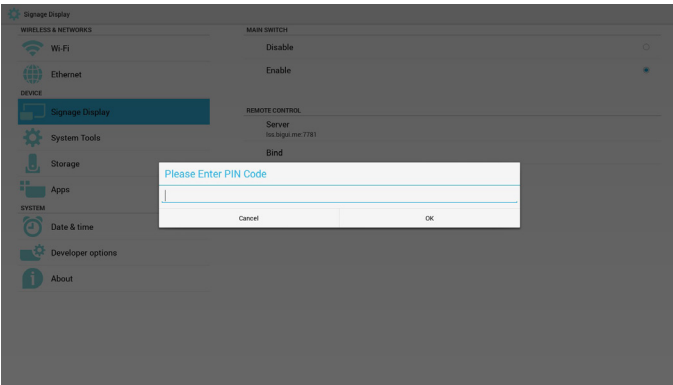

Bind status:

(3) Will show Server is unbinded if Remote control server feedback unbinded status.

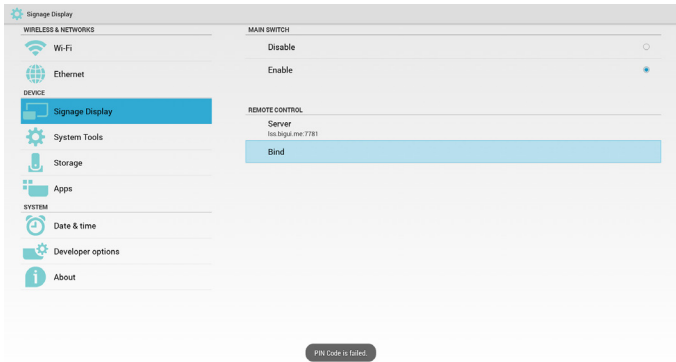

Bind status:

(4) Will show server is binded if Sever binded successfully.

(1) Open Media Player Player List edit page.

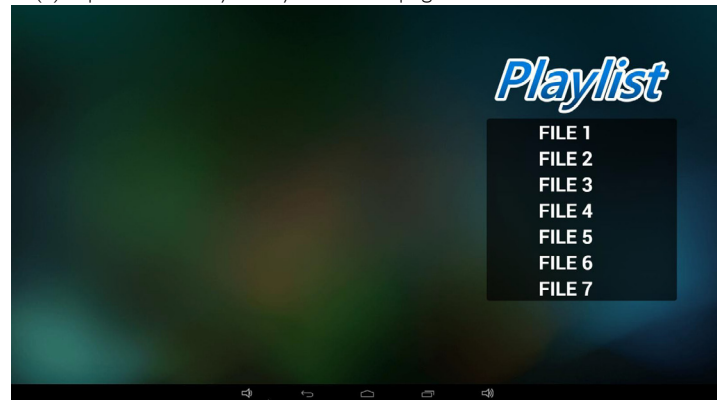

(2) Open Media Player slideshow effect edit page.

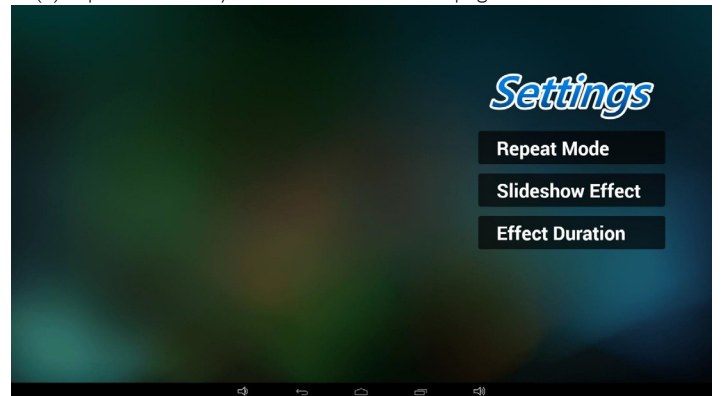

Bind status:

(5) Will show Error PIN code if input incorrect PIN code.

2. Browser

Can edit Bookmark configuration.

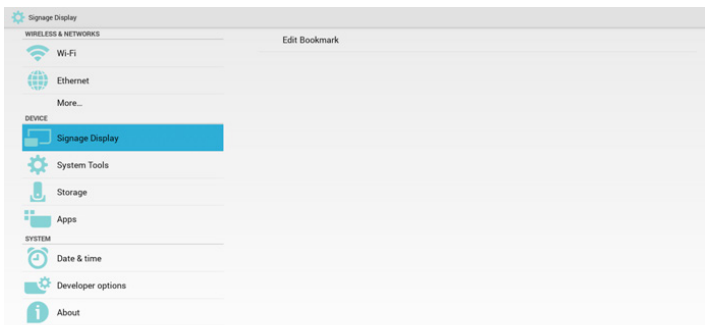

(1) Open Browser setting page.

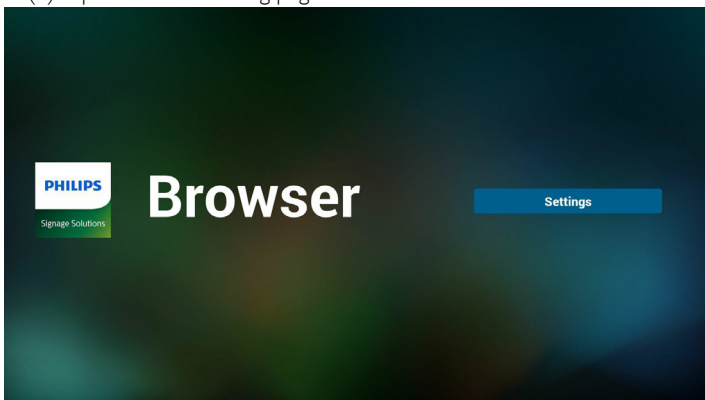

3. SmartCMS



1) Server

Set up SmartCMS Server address.

2) Account

Set up SmartCMS account.

Note:

Input format limitation:ASCII only (refer to 11.2 ASCII Table)

3) PIN Code

Set up SmartCMS PIN Code

4) Version

Can select Ver. 2 and Ver. 3

- Ver. 2: Using 2.0/2.2 update advertising agreement.
- Ver. 3: Using 3.0/3.1 update advertising agreement.

In Ver. 2 cases, do not use Server/Account/PIN Code values, so the three gray and cannot be used.

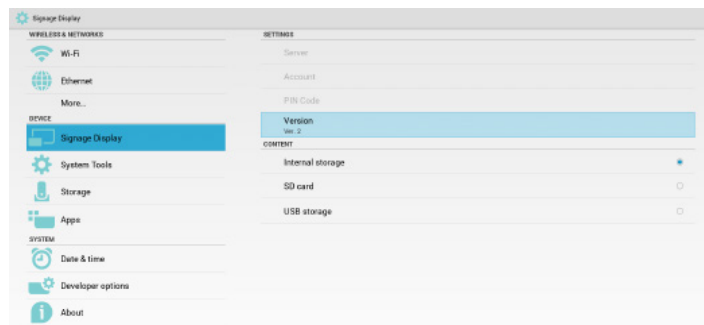

5) Content

Can select Internal storage/SD card/USB storage.

4. PDF Player

Can edit PDF Player Play List and Effect Settings.

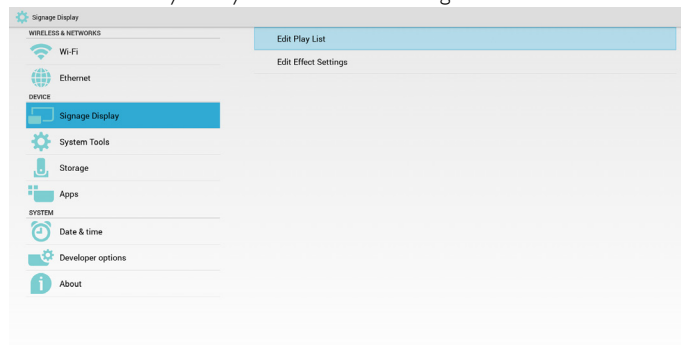

(1) Open PDF Player Player List edit page.

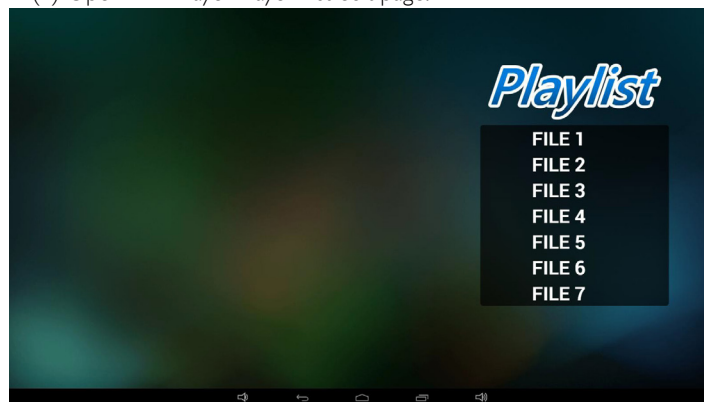

(2) Open PDF Player effect edit page.

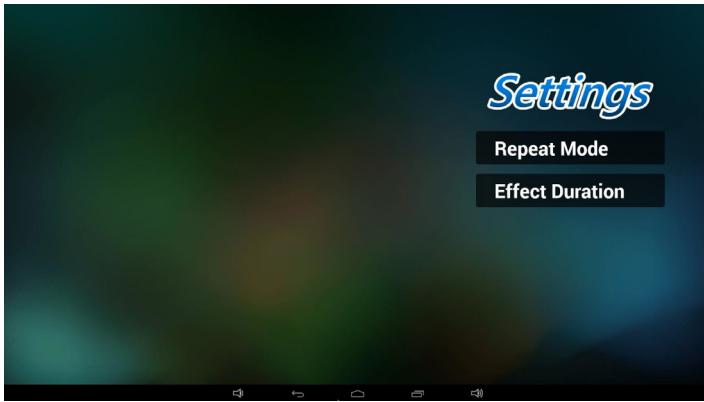

5. Custom app

Please refer to Page 27 Custom app

5.5. System Tools

System tools 3 main functions:

- (1) Clear Storage
- (2) Factory Reset
- (3) Import & Export

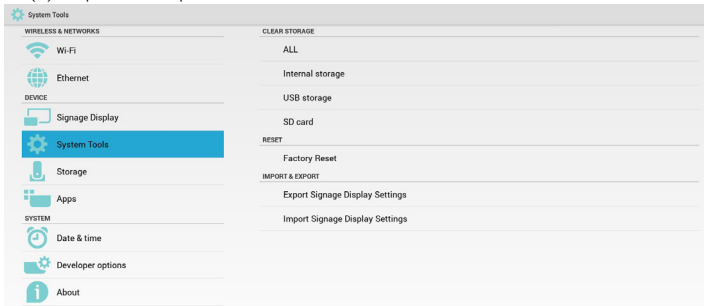

5.5.1. Clear Storage

The purpose is to clear all data in Philips folders.

Divided into 4 mode:

- (1) Clear all Philips folde
- (2) Only clear Philips folder under Internal storage.
- (3) Only clear Philips folder under USB storage.
- (4) Only clear Philips folder under SD card.

Pop-up the window to display all folders which can be clear.

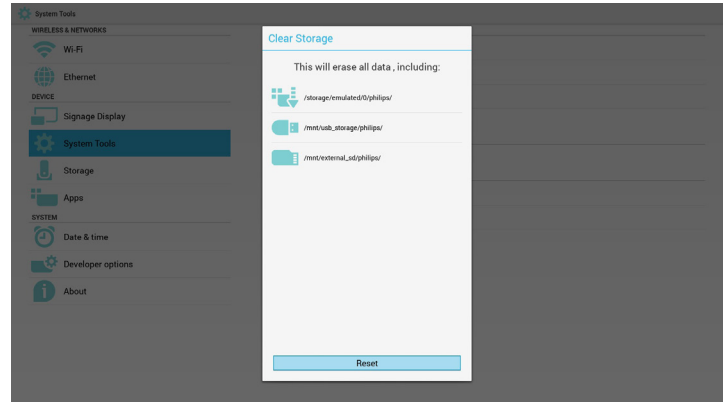

5.5.2. Factory Reset

Factory Reset can recover to Factory default settings.

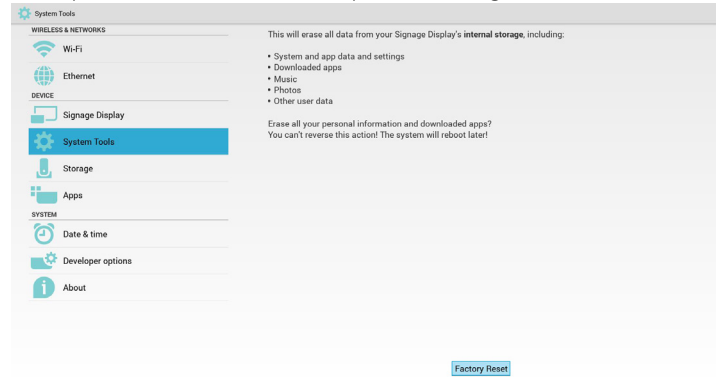

Press OK to execute Reset function automatically.

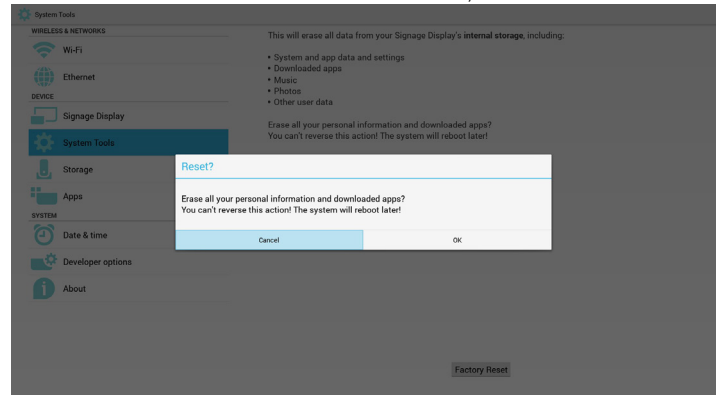

5.5.3. Import & Export

The function of Import & Export PD settings.

Note:

- (1) Saved file name: settings.db
- (2) Will save to Philips folder in storage.

1. Export

Will export settings.db to Philips folder under USB or SD card.

Note:

If no Philips folder exists in USB or SD card, it will be created automatically.

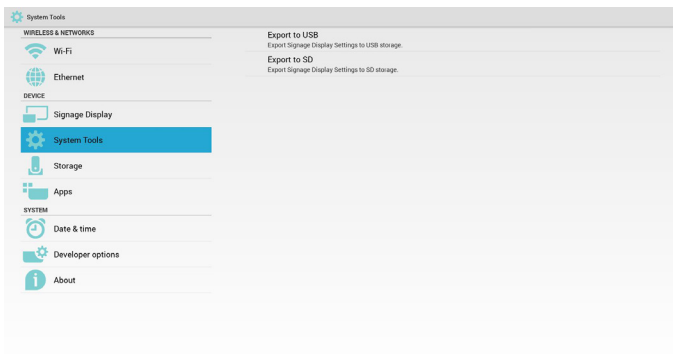

2. Import

Import settings.db from Philips folder under USB or SD card.

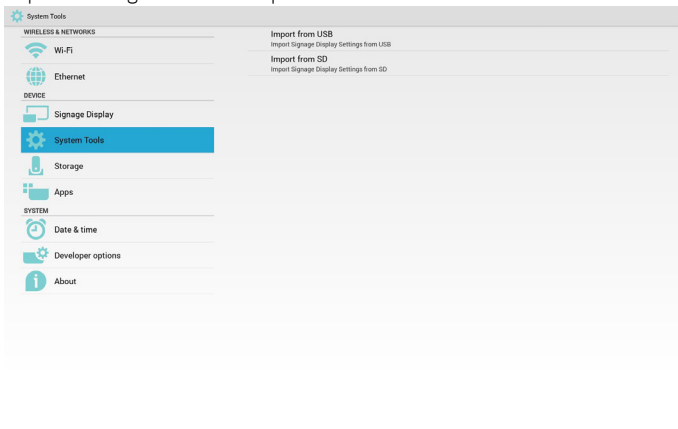

5.6. Storage

Display current PD Android storage information.

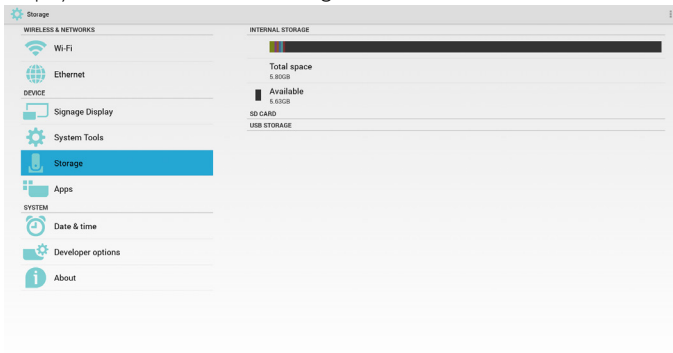

SD CARD and USB STORAGE :

Need to insert SD card or USB, the information will show up total space and available of SD card or USB storage.

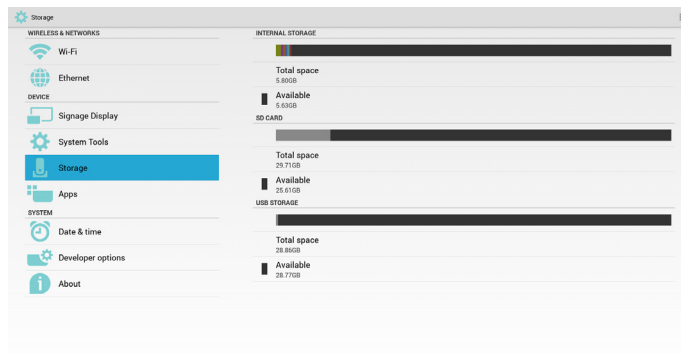

5.7. Apps

Display applications information.

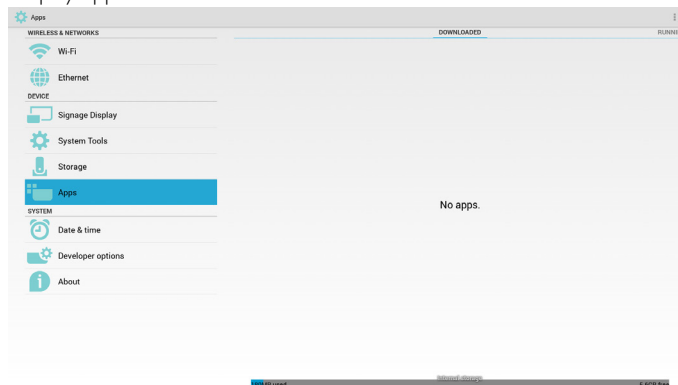

5.8. Date & time

Via Scalar OSD menu to control Auto Time On/Off.

When Salar OSD menu turn off Auto time, user can set up Time Zone manually.

Note:

Add new NTP server to display current serverIP.

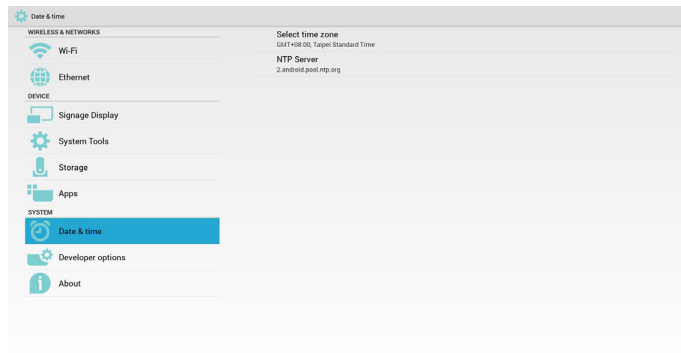

5.9. Developer options

Android developer options.

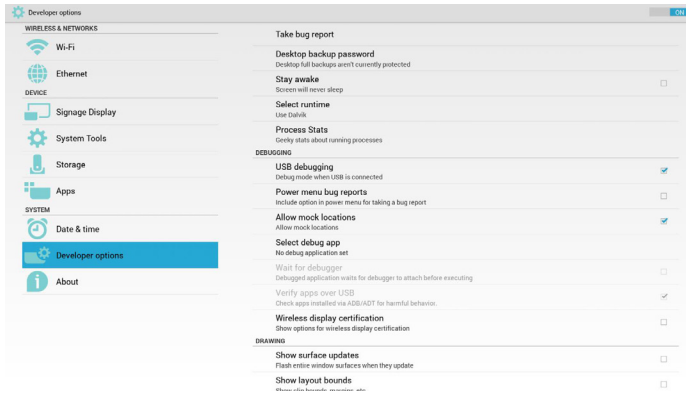

5.10. About

Main info in About:

- (1) System updates
- (2) Android version
- (3) Kernel version
- (4) Build number

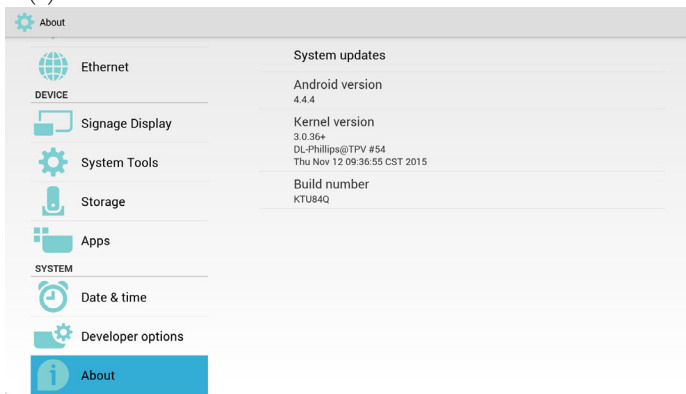

5.10.1. System updates

Will automatically search update.zip in USB or SD card.

Will be shown in list for user selection if found

Note:

- (1) Only support Android Full image.
- (2) file name should be update.zip.
- (3) the file should be located in root of storage.

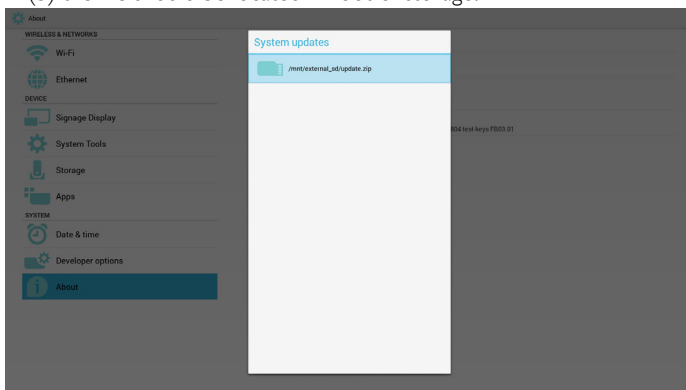

After select update.zip file, PD will restart and start to update.

5.11. Supplementary

5.11.1. Rotation

Via Scalar OSD menu to operate Rotation:

Home -> Configuration2 -> Rotation -> OSD rotation

1. Landscape

After set up Landscape mode, the setting screen will divide into 2 part. Select Left item, right side will display the sub menu.

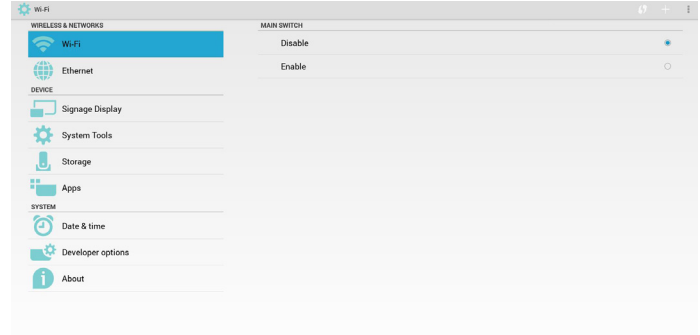

2. Portrait

After set up Portrait mode, the setting screen only display one layer.

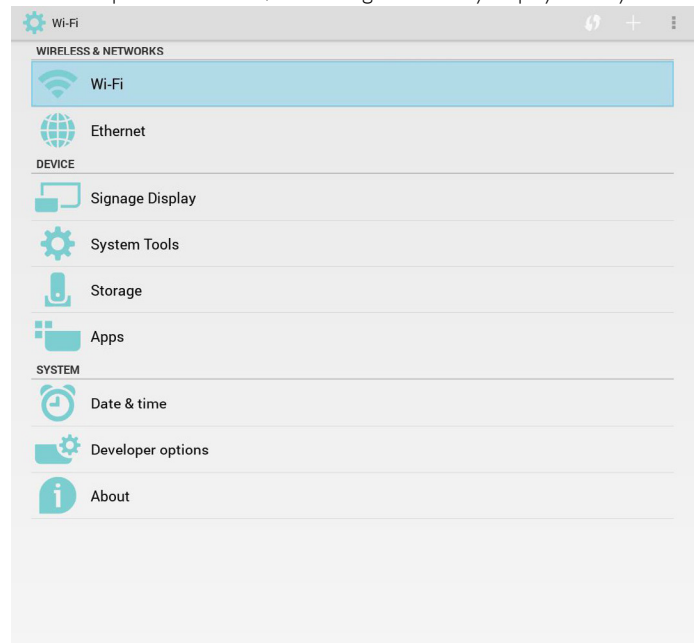

5.11.2.ASCII Table

ASCII TABLE

Decimal	Hex	Char	Decimal	Hex	Char	Decimal	Hex	Char	Decimal	Hex	Char
0	0	[NULL]	32	20	[SPACE]	64	40	@	96	60	`
1	1	[START OF HEADING]	33	21	!	65	41	A	97	61	a
2	2	[START OF TEXT]	34	22	"	66	42	B	98	62	b
3	3	[END OF TEXT]	35	23	#	67	43	C	99	63	c
4	4	[END OF TRANSMISSION]	36	24	\$	68	44	D	100	64	d
5	5	[ENQUIRY]	37	25	%	69	45	E	101	65	e
6	6	[ACKNOWLEDGE]	38	26	&	70	46	F	102	66	f
7	7	[BELL]	39	27	'	71	47	G	103	67	g
8	8	[BACKSPACE]	40	28	(72	48	H	104	68	h
9	9	[HORIZONTAL TAB]	41	29)	73	49	I	105	69	i
10	A	[LINE FEED]	42	2A	*	74	4A	J	106	6A	j
11	B	[VERTICAL TAB]	43	2B	+	75	4B	K	107	6B	k
12	C	[FORM FEED]	44	2C	,	76	4C	L	108	6C	l
13	D	[CARRIAGE RETURN]	45	2D	-	77	4D	M	109	6D	m
14	E	[SHIFT OUT]	46	2E	.	78	4E	N	110	6E	n
15	F	[SHIFT IN]	47	2F	/	79	4F	O	111	6F	o
16	10	[DATA LINK ESCAPE]	48	30	0	80	50	P	112	70	p
17	11	[DEVICE CONTROL 1]	49	31	1	81	51	Q	113	71	q
18	12	[DEVICE CONTROL 2]	50	32	2	82	52	R	114	72	r
19	13	[DEVICE CONTROL 3]	51	33	3	83	53	S	115	73	s
20	14	[DEVICE CONTROL 4]	52	34	4	84	54	T	116	74	t
21	15	[NEGATIVE ACKNOWLEDGE]	53	35	5	85	55	U	117	75	u
22	16	[SYNCHRONOUS IDLE]	54	36	6	86	56	V	118	76	v
23	17	[ENG OF TRANS. BLOCK]	55	37	7	87	57	W	119	77	w
24	18	[CANCEL]	56	38	8	88	58	X	120	78	x
25	19	[END OF MEDIUM]	57	39	9	89	59	Y	121	79	y
26	1A	[SUBSTITUTE]	58	3A	:	90	5A	Z	122	7A	z
27	1B	[ESCAPE]	59	3B	;	91	5B	[123	7B	{
28	1C	[FILE SEPARATOR]	60	3C	<	92	5C	\	124	7C	
29	1D	[GROUP SEPARATOR]	61	3D	=	93	5D]	125	7D	}
30	1E	[RECORD SEPARATOR]	62	3E	>	94	5E	^	126	7E	~
31	1F	[UNIT SEPARATOR]	63	3F	?	95	5F	_	127	7F	[DEL]

6. OSD Menu

An overall view of the On-Screen Display (OSD) structure is shown below. You can use it as a reference for further adjusting your display.

6.1. Navigating the OSD Menu

6.1.1. Navigating the OSD menu using the remote control

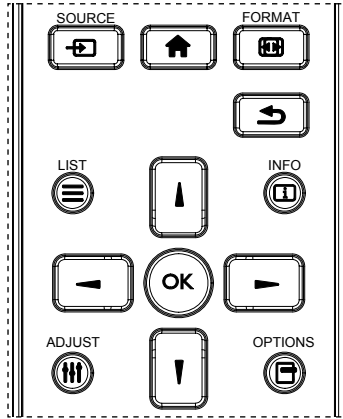

1. Press [**HOME**] button on the remote control to display the OSD menu.
2. Press [**UP**] or [**DOWN**] button to choose the item you want to adjust.
3. Press [**OK**] or [**RIGHT**] button to enter the submenu.
4. In the submenu, press [**UP**] or [**DOWN**] button to toggle among items, press [**LEFT**] or [**RIGHT**] button to adjust settings. If there is a submenu, press [**OK**] or [**RIGHT**] button to enter the submenu.
5. Press [**BACK**] button to return to the previous menu, or press [**HOME**] button to exit the OSD menu.

NOTES:

- When there is no OSD menu on the screen, press [**UP**] to display the menu of {Smart picture}.
- When there is no OSD menu on the screen, press [**DOWN**] to display the menu of {Audio source}.

6.1.2. Navigating the OSD menu using the display's control buttons

1. Press [**MENU**] button to display the OSD menu.
2. Press [**+**] or [**-**] button to choose the item you want to adjust.
3. Press [**+**] button to enter the submenu.
4. In the submenu, press [**▲**] or [**▼**] button to toggle among items, press [**+**] or [**-**] button to adjust settings. If there is a submenu, press [**+**] button to enter the submenu.
5. Press [**MENU**] button to return to the previous menu, or press [**MENU**] button several times to exit the OSD menu.

6.2. OSD Menu Overview

6.2.1. Picture menu

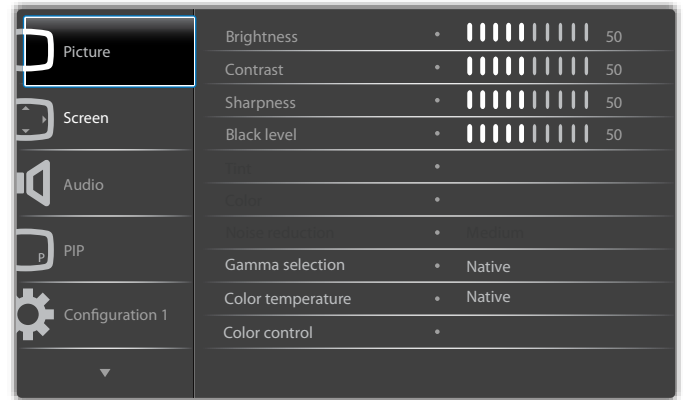

Brightness(Picture)

Adjust the overall image and background screen brightness(backlight).

Contrast

Adjust the image contrast ratio for the input signal.

Sharpness

This function is digitally capable to keep crisp image at any timings. It is adjustable to get a distinct image or a soft one as you prefer and set independently for each picture mode.

Black level

Adjust the image brightness for the background.

NOTE: sRGB picture mode is standard and cannot be changed.

Tint(Hue)

Adjust the tint of the screen.

Press + button the flesh tone color becomes greenish.

Press - button the flesh tone color becomes purplish.

NOTE: VIDEO mode only.

Color(Saturation)

Adjust the color of the screen.

Press + button to increase color depth.

Press - button to decrease color depth.

NOTE: VIDEO mode only

Noise Reduction

Adjust the noise reduction level.

Gamma selection

Select a display gamma, It's refer to the brightness performance curve of signal input. Choose from {Native} / {2.2} / {2.4} / {s gamma} / {D-image}.

NOTE: sRGB picture mode is standard and cannot be changed.

Color temperature

It is used to adjust the color temperature.

The image becomes reddish as the color temperature decreases, and becomes bluish as the color.

CCT	10000° K	9300 ° K	7500 ° K	6500 ° K	5000 ° K	4000 ° K	3000 ° K
X	0.279 ± 0.030	0.283 ± 0.030	0.299 ± 0.030	0.313 ± 0.030	0.346± 0.030	0.382± 0.030	0.440± 0.030
Y	0.292 ± 0.030	0.298 ± 0.030	0.315 ± 0.030	0.329 ± 0.030	0.359± 0.030	0.384± 0.030	0.403± 0.030

Color control

The color levels of red, green, and blue are adjusted by the color bars.

R: Red gain, G: Green gain, B: Blue gain.

Smart picture

PQ setting

PC mode: {Standard} / {Highbright} / {sRGB}.

Video mode: {Standard} / {Highbright} / {Cinema}.

Smart Contrast

Auto detect black data and white data on content and set suitable backlight.

Surface Ratio	Backlight Setting
5%-90%	(MaxBacklight-MinBacklight)* Surface Ratio/100
<5%	Min Backlight
>90%	Max Backlight

Smart power

Smart Power control is not relative to brightness control:

- Initial setting Brightness
70 (in the range from 0-100)
Power consumption 70% of maximum power consumption
- Smart Power
OFF: no adaptation
MEDIUM: 80% of power consumption relative to current settings
HIGH: 65% of power consumption relative to current settings
- Panel saving/Brightness ON: 40% of maximum power consumption

The controls settings should only be visible on its own controls. It should not have secondary effects on other controls

(ea brightness setting changes when smart power setting has changed).

Overscan

Change the display area of the image.

ON: Set to display area about 95%.

OFF: Set to display area about 100%.

Picture reset

Reset all settings in the Picture menu.

Select "Yes" and press "SET" button to restore to factory preset data.

Press "EXIT" button to cancel and then return to the previous menu.

6.2.2. Screen menu

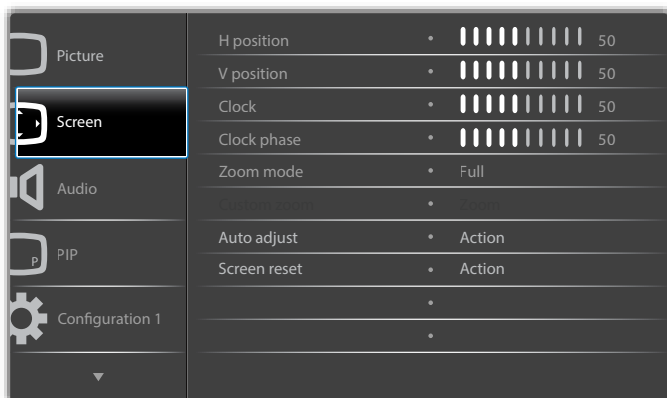

H position

Control Horizontal Image position within the display area of the LCD.

Press + button to move screen to right.

Press - button to move screen to left.

V position

Control Vertical Image position within the display area of the LCD.

Press + button to move screen to up.

Press - button to move screen to down.

Clock

Press + button to expand the width of the image on the screen the right.

Press - button to narrow the width of the image on the screen the left.

NOTE:VGA input only.

Clock phase

Improves focus, clarity and image stability by increasing or decreasing this setting.

NOTE:VGA input only

Zoom mode

PC mode: {Full} / {4:3} / {1:1} / {16:9}/ {21:9}/ {Custom}.

Video mode: {Full} / {4:3} / {1:1} / {16:9}/ {21:9}/ {Custom}.

*Zoom mode setting is by input. If input in multi-windows, the setting will apply for windows with the same input.





And the INFO OSD will show the latest setting.

	<p>Full</p> <p>This mode restores the correct proportions of pictures transmitted in 16:9 using the full screen display.</p>
	<p>4:3</p> <p>The picture is reproduced in 4:3 format and a black band is displayed on either side of the picture..</p>
	<p>1:1</p> <p>This mode displays the image pixel-by-pixel on screen without scaling the original image size.</p>
	<p>16:9</p> <p>The picture is reproduced in 16:9 format and a black band at the top and bottom.</p>
	<p>21:9</p> <p>The picture is reproduced in 21:9 format and a black band at the top and bottom.</p>
	<p>Custom</p> <p>Choose to apply the custom zoom settings in the Custom Zoom submenu.</p>

Custom zoom

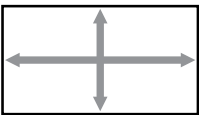
You can use this function to further customize the zoom settings to suit the image you want to display.

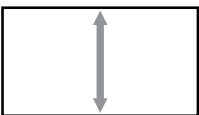
NOTE: This item is functional only when the {Zoom mode} is set to {Custom}.

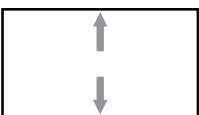
	Zoom Expands the horizontal and vertical sizes of the image simultaneously.
	H zoom Expands the horizontal size of the image only.
	V zoom Expands the vertical size of the image only.
	H position Moves the horizontal position of the image left or right.
	V position Moves the vertical position of the image up or down.

Auto adjust

Press "Set" to detect and adjust H position, V position, Clock, Phase automatically.

Screen reset

Reset all settings in the **Screen** menu to factory preset values.

Select "Yes" and press "SET" button to restore the factory preset data.

Press "EXIT" button to cancel and then return to the previous menu.

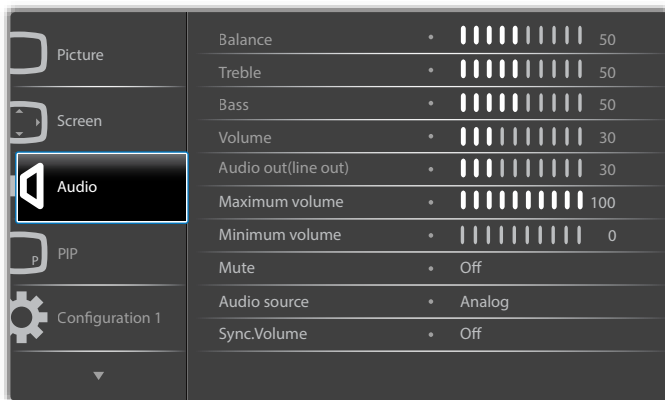
6.2.3. Audio menu**Balance**

Adjust to emphasize left or right audio output balance.

Treble

Adjust to increase or decrease higher-pitched sounds.

Bass

Adjust to increase or decrease lower-pitched sounds.

Volume

Adjust to increase or decrease the audio output level.

Audio out (line out)

Adjust to increase or decrease line out output level.

Maximum volume

Adjust your own limitation for the maximum volume setting. This stops the volume from being played too loudly.

Minimum volume

Adjust your own limitation for the minimum volume setting.

Mute

Turn the mute function on/off.

Audio source

Select the audio input source.

Analog: audio from audio input

Digital : audio from HDMI/DVI audio.

Displayport: audio from DP.

Sync. Volume

Enable/disable audio out (line out) volume adjustability to sync with internal speakers.

Audio reset

Reset all settings in the **Audio** menu to factory preset values.

6.2.4. PIP menu

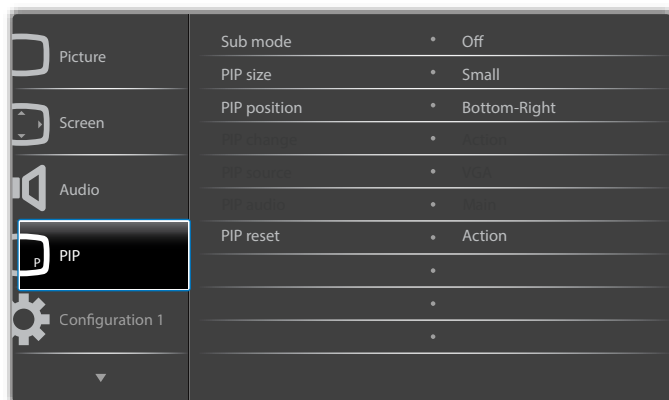

Sub mode

Select the sub mode.

Choose from: {Off} / {PIP} / {POP} / {Quick swap} / {PBP}.

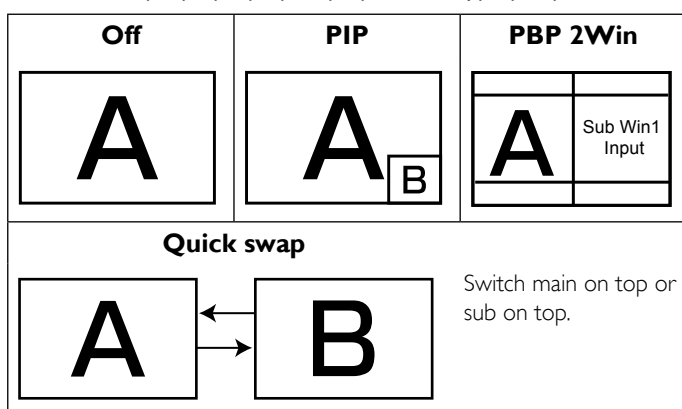

PIP size

Select the size of the sub picture in the PIP (Picture-in-Picture) mode.

Choose from: {Small} / {Medium} / {Large}.

PIP position

Select the position of the sub picture in the PIP (Picture-in-Picture) mode.

Choose from: {Bottom-Right} / {Bottom -Left} / {Top-Right} / {Top-Left}.

PIP change

Exchange Main and PIP / PBP / Quick swap input signal.

PIP source

Select the input signal for the sub picture.

PIP audio

Select the audio source in the Sub mode.

- {Main} - Select audio from the main picture
- {Sub} - Select audio from the sub picture.

PIP reset

Reset all settings in the PIP menu to factory preset values.

- The PIP function is available only for certain signal source combinations as shown in the table below.

	HDMI1	HDMI2	DVI	DisplayPort	VGA	Medoa Player	Browser	SmartCMS	PDF Reader	Custom
HDMI1	○	×	×	○	○	×	×	×	×	×
HDMI2	×	○	×	○	○	×	×	×	×	×
DVI	×	×	○	○	○*	×	×	×	×	×
DisplayPort	○	○	○	○	○	○	○	○	○	○
VGA	○	○	○*	○	○	○	○	○	○	○
Medoa Player	×	×	×	○	○	○	×	×	×	×
Browser	×	×	×	○	○	×	○	×	×	×
SmartCMS	×	×	×	○	○	×	×	○	×	×
PDF Reader	×	×	×	○	○	×	×	×	○	×
Custom	×	×	×	○	○	×	×	×	×	○

(○: PIP function available, ×: PIP function unavailable)

- The availability of the PIP function will also depend on the resolution of the input signal being used.

6.2.5. Configuration1 menu

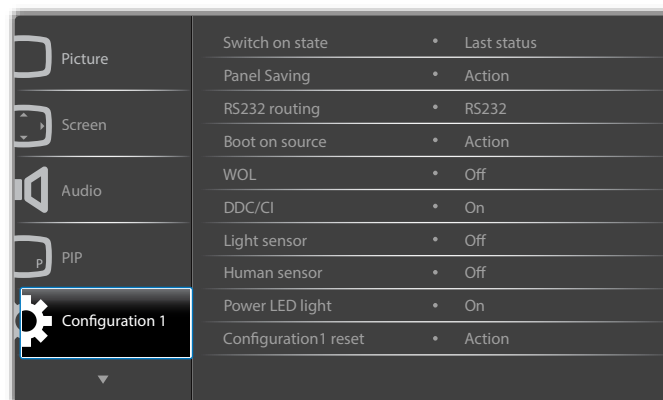

Switch on state

Select the display status used for the next time you connect the power cord.

- {Power off} - The display will remain off when the power cord is connected to a wall outlet.
- {Forced on} - The display will turn on when the power cord is connected to a wall outlet.
- {Last status} - The display will return to the previous power status (on/off/standby) when removing and replacing the power cord.

Panel saving

Choose to enable the panel saving functions and thus reduce the risk of "image persistence" or "ghost-imaging".

- {Brightness} - Select {On} and the image brightness will be reduced to an appropriate level. The Brightness setting in the Picture menu will be unavailable when selected.
- {Pixel shift} - Select the time interval ({Auto} / {10 ~ 900} Seconds / {Off}) for the display to slightly expand the image size and shift the position of pixels in four directions (up, down, left, or right).

RS232 routing

Select the network control port.

Choose from: {RS232} / {LAN ->RS232}.

Boot on source

Choose to select source when boot up.

Input: select input source when bootup.

Playlist: select playlist index for Media player; Browser; PDF player.

0: no play list. Same as switch source from OSD.

1~7: playlist number.

WOL

Choose to turn on or off the wake on LAN function.

Choose from : {Off} / {On}

DDC/CI

Choose to turn on or off the DDC/CI communication function.

Select {On} for normal use.

Light sensor(require Philips accessory CRD41 External Sensor Box)

Choose to turn on or off backlight adjustment according to environment brightness.

Choose from : {Off} / {On}

Human sensor(require Philips accessory CRD41 External Sensor Box)

The Human sensor can detect if people approach the display or not.

The display will turn off backlight if detect nothing in setting time.

The display will back to backlight on when people approach it.

The options are:

- {Off} (Default), {10 Min.}, {20 Min.}, {30 Min.}, {40 Min.}, {50 Min.}, {60 Min.}

Power LED light

Choose to set power indicate LED on or off.

Choose {On} for normal use.

Configuration1 reset

Reset all settings in **Configuration1** menu to the factory preset values.

Factory reset

Reset all settings in the OSD menus of {Picture}, {Screen}, {Audio}, {PIP}, {Configuration1}, {Configuration2}, and {Advanced option} to the factory preset values.

Android settings will also reset when factory reset.

Press [←] or [→] button to select {Reset}, and press [OK] button to do the reset.

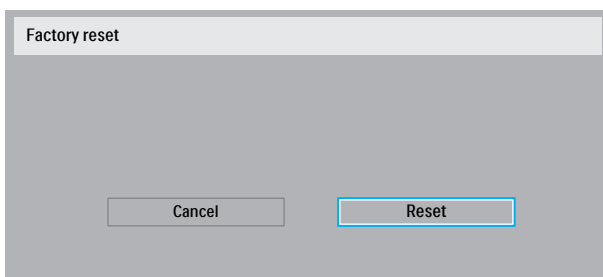

6.2.6. Configuration2 menu

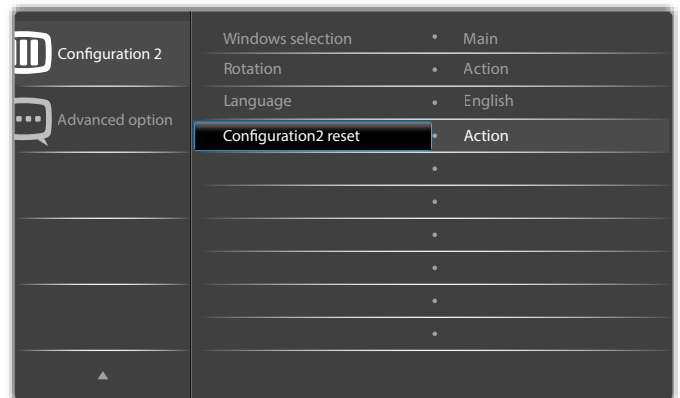
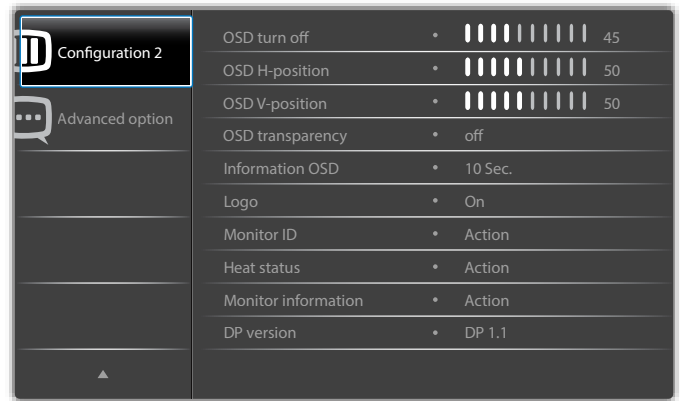

OSD turn off

Set the period of time the OSD (on-screen display) menu stays on the screen.

The options are: {0 ~ 120} seconds.

*{0} does not disappear automatically.

OSD H-position

Adjust the horizontal position of the OSD menu.

OSD V-position

Adjust the vertical position of the OSD menu.

OSD Transparency

Adjust OSD transparency.

- {Off} - Transparency off.
- {1-100} - Transparency level 1-100.

Information OSD

Set the period of time the information OSD is displayed on the upper right corner of the screen. The information OSD will display when input signal is changed.

The information OSD will remain on the screen with {Off} selection.

The options are: {1 ~ 60} seconds.

Logo

Choose to enable or disable the picture of Logo when turn on your display.

The options are:

- {Off} (Default)
- {On}*
- {User}**

** If Logo set to USER.

User logo does NOT support rotation function.

Monitor ID

Set the ID number for controlling the display via the RS232C connection. Each display must have a unique ID number when multiple sets of this display are connected. Monitor ID number range is between 1 to 255.

The option are: {**Monitor group**} / {**Tiling matrix**} / {**Auto ID**}

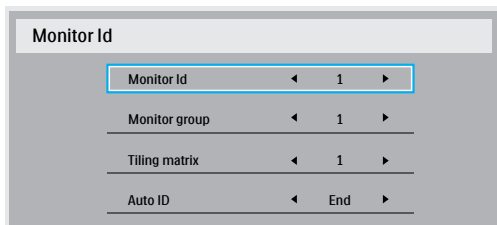

- {**Monitor group**}

The options are: {**Off**} / {**1-254**}

- {**Off**} – {**Monitor group**} are not supported.
- {**1-254**} – {**Monitor group**} are supported. The default setting is 1.

- {**Tiling matrix**}

Tiling matrix number range is between 1 to 15. 1 is default setting. The {**Auto ID**} setup function enables setting up {**Monitor ID**} of connected machine according to {**Tiling matrix**} settings.

Example: Tiling matrix sets as 4

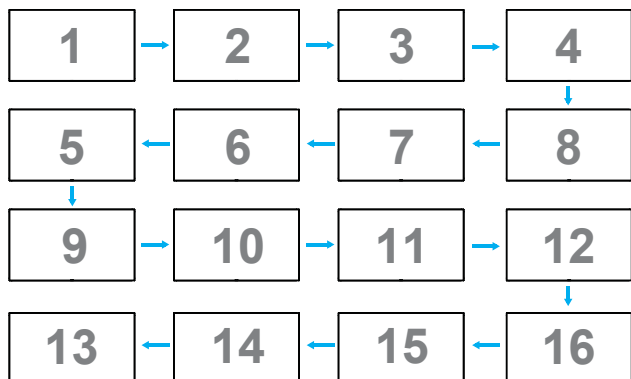

- {**Auto ID**}

The option are: {**Start**} / {**End**}. The default is {**End**}.

- Switch to Start option to set up IDs of machines backward from current one.
- Once the setup is completed, the option exits to End automatically.
- To use this function, serial connect all machines with RS-232 cable and set their Control ports to RS-232 too.

Heat status

This function allows you to check the thermal status at any time.

- A temperature-warning message will be shown on the screen if the temperature reaches 97°C (207°F). All key functions except [⏻] key will then be disabled.
- Once the temperature reaches 98°C (208°F), the display power will be shut down automatically.

Monitor information

Shows information about your display, including model number, serial number, operating hours and software version.

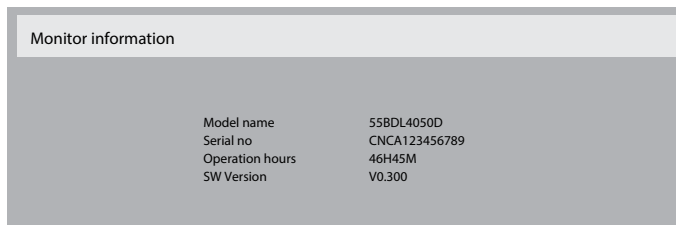

DP version

DisplayPort support mode.

The options are:

- {**DP 1.1**} (**Default**) : DP 1.1 single stream(clone mode)
- {**DP 1.2 SST**}: DP 1.2 Single stream(clone mode)
- {**DP 1.2 MST**}: DP 1.2 Multi-Stream

*NOTE:

The DP version must be set the same for all daisy chain displays.

Window selection

Select the window for adjusting setting. The selected window will be highlight green border.

Window selection will set to Main after power on.

The options are:

- {**Main**} (**Default**), {**PIP**}
- [■] Hot key for Window selection function.

Rotation

Set the rotation of Main/Sub/OSD

Auto Rotate :	Off/On	Default : Off
OSD Rotate :	Landscape/Portrait	Default : Landscape
Image Rotate:		
All :	Off/On	Default : Off
Main :	Off/On	Default : Off
Sub :	Off/On	Default : Off

Auto Rotate: {**Off**}, {**On**} when value is On, automatically detect whether the PD rotation, Off is set by OSD.

OSD Rotate: {**Off**}, {**On**} when value is on, OSD rotate 90 °, Off is restored.

All: {**Off**}, {**On**} when value is on, all Window screen rotate 90 °, Off the reference set individual window.

Main: {**Off**}, {**On**} when value is on, Main window screen rotate 90 °, Off is restored.

Sub: {**Off**}, {**On**} when value is on, Sub1 Window screen rotate 90 °, Off is restored.

* When the Main / Sub source is the same, rotation is given priority to with Sub.

* Not supported De-Interlacing function in rotation mode.

Language

Select the language used in the OSD menu.

The options are: English/Deutsch/ 简体中文 /Français/Italiano/Español/ Русский/PolSKI/Türkçe/ 繁體中文 / 日本語 /Português/ العربية /Danish/ Svenska/Suomi/Norsk/Nederlands.

Configuration2 reset

Reset all settings in **Configuration2** menu to the factory preset values.

6.2.7. Advanced option menu

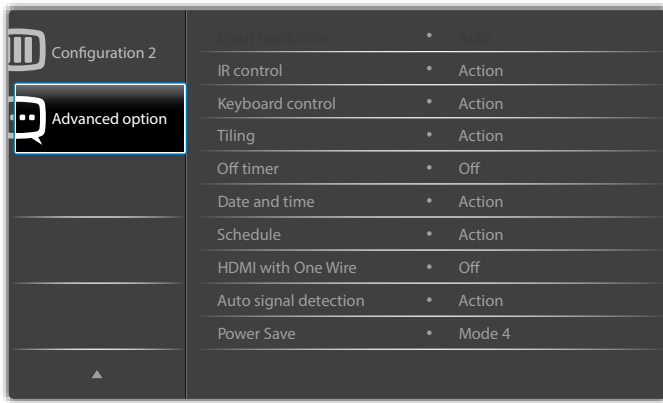

Input resolution

Set the resolution of the VGA input. This is only required when the display is unable to detect the VGA input resolution correctly.

NOTE: This item is functional for **VGA** input only.

The options are:

- {1024x768 / 1280x768 / 1360x768 / 1366x768}
- {1400x1050 / 1680x1050}
- {1600x1200 / 1920x1200}
- {Auto}: Determines the resolution automatically.

The selected settings will become effective after turning off the power and turning it on again.

IR control

Select the operation mode of the remote control when multiple displays are connected via an RS232C connection.

- {Normal} - All displays can be operated normally by the remote control unit.
- {Primary} - Designate this display as the primary display for remote control operation. Only this display can be operated by the remote control. (In primary mode, IR key will always be processed regardless the monitor id/group settings).
- {Secondary} - Designate this display as the secondary display. This display can not be operated by the remote control, and will only receive the control signal from the primary display via the RS232C connection.
- {Lock All} / {Lock all but Volume} / {Lock all but Power} / {Lock all except PWR & VOL} - Lock the remote control function of this display. To unlock, press and hold the [i] INFO button on the remote control for 6 (six) seconds.

Keyboard control

Choose to enable or disable the display keyboard (control buttons) function.

- {Unlock} - Enable the keyboard function.
- {Lock All} / {Lock all but Volume} / {Lock all but Power} / {Lock all except PWR & VOL} - Disable the keyboard function.

NOTE: "Keyboard Control Lock Mode" This function completely disables the access to all Keyboard Control functions. To enable or disable the keyboard control lock, press both [+] and [A] buttons and hold down continuously for more than 3 seconds.

Tiling

With this function you can create a single large-screen matrix (video wall) that consists of up to 225 sets of this display (up to 15-sets on the vertical and 15-sets on the horizontal sides). This function requires a daisy-chain connection.

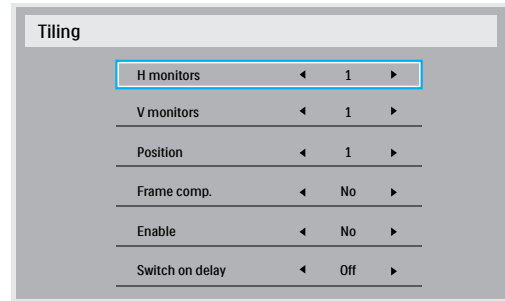

Example: 2 x 2 screen matrix (4 displays)

H monitors = 2 displays

V monitors = 2 displays

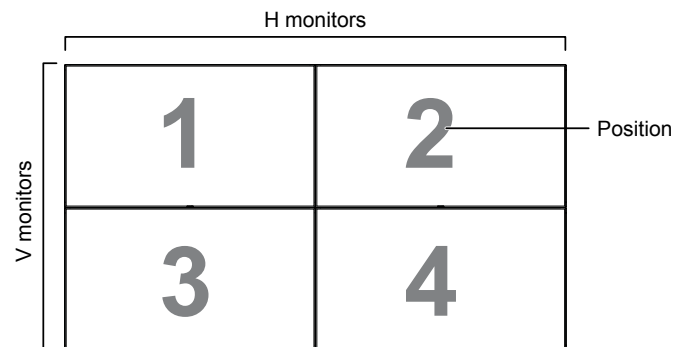

Example: 5 x 5 screen matrix (25 displays)

H monitors = 5 displays

V monitors = 5 displays

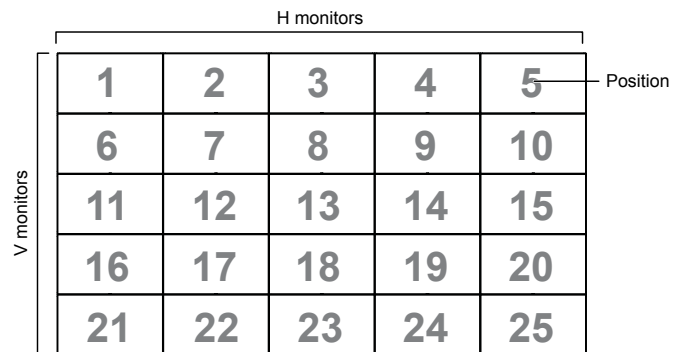

- {H monitors} - Select the number of displays on the horizontal side.
- {V monitors} - Select the number of displays on the vertical side.
- {Position} - Select the position of this display in the screen matrix.
- {Frame comp.} - Choose to turn the frame compensation function on or off. If selected {Yes}, the display will adjust the image to compensate for the width of the display bezels in order to accurately display the image.

Frame compensation - Yes

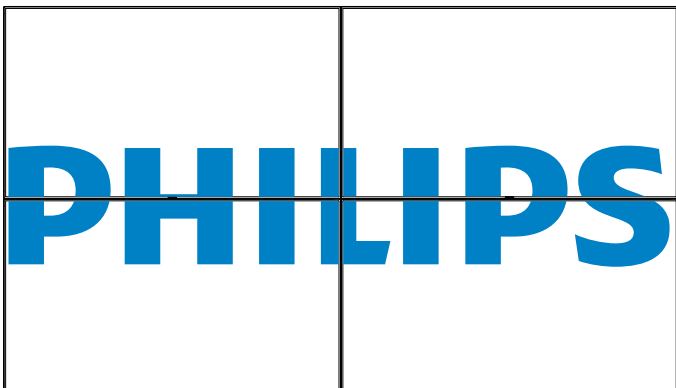

Frame compensation - No

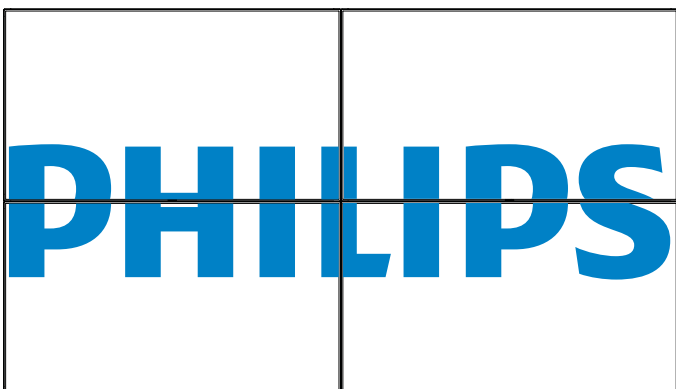

- **{Enable}** - Choose to enable or disable the Tiling function. If enabled, the display will apply the settings in **{H monitors}**, **{V monitors}**, **{Position}**, and **{Frame comp.}**.
- **{Switch on delay}** - Set the power-on delaying time (in seconds). The default option **{Auto}** allows a sequential powering-on for each display by their ID number when multiple displays are connected. The options are: **{Off/Auto/2-255}**
- **Brightness: {Normal}/{ACS}**

{Normal}: Apply OSD brightness value (backlight)

{ACS}: Apply brightness value (backlight) which is adjusted by MIC tool. The default value before adjustment is the same as OSD brightness value, e.g., 70)

Some brightness (backlight) settings cannot be adjusted by OSD. Please refer to Picture Menu Backlight setting priority.

Off Timer

Set automatically power off time (in hours).

Date and time

Adjust the current date and time for the display's internal clock.

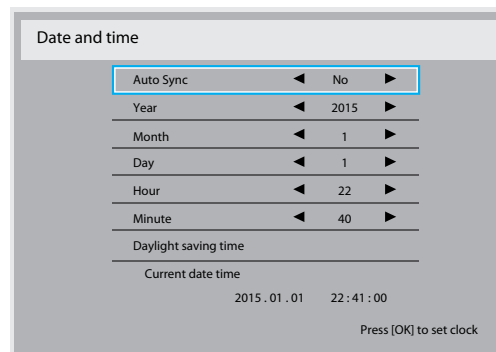

1. Press **[OK]** button to enter the submenu.
2. Press **[▲]** or **[▼]** button to toggle between **{Year}**, **{Month}**, **{Day}**, **{Hour}**, **{Minute}**, and **{Daylight saving time}**.
3. Press **[←]** or **[→]** button to adjust all settings except **{Daylight saving time}**.
4. Press **[OK]** button to enter the **{Daylight saving time}** submenu.
5. Press **[←]** or **[→]** button to select item, press **[▲]** or **[▼]** button to adjust.

The Daylight saving time definition and behavior:

The current implementation of daylight saving is a reminder tool for the customer which doesn't know how to adjust the clock for daylight saving on and off. It does not adjust the real time clock automatically. Problem is that there are no stable rules per region, or country when to adjust the clock. To solve this the user must be able to set the daylight saving start and stop date. When daylight saving correction is on (user selectable) then the real time clock should be adjusted at the moment in time set in the daylight saving on and off date. At daylight start date the clock should be put forward 1 hour at 2 o'clock. At daylight stop date the clock should be put back 1 hour at 2 o'clock.

The existing daylight on/off menu item should be replaced with the following menu structure:

- Menu item <Daylight saving setup> opens submenu containing the following items:
 - Menu item <Daylight-saving start date> Selection item <1st, 2nd, 3rd, 4th, last> Sunday of selection item <1-12 month>
 - Menu item <Daylight-saving stop date> Selection item <1st, 2nd, 3rd, 4th, last> Sunday of selection item <1-12 month>
 - optional
 - Menu item <Correction time> Selection item <0.5, 1.0, 1.5, 2.0> hour
 - Menu item <Daylight saving correction> Selection item <on, off>
- when "daylight saving" is "on" the real time clock would have been adjusted automatically for winter and summer time when passing the critical moment in time (eg march 29, 2009, 02.00 o'clock: time will be set 1 hour later or October 25, 2009, 02.00 o'clock: time will be set 1 hour earlier)

Schedule

This function allows you to program up to 7 (seven) different scheduled time intervals for the display to activate.

You can select:

- The time for the display to turn on and turn off.
- The days in a week for the display to activate.
- Which input source the display will use for each scheduled activation period.

NOTE: We recommend you to set up current date and time in the {Date and time} menu before using this function.

1. Press [OK] or [←] button to enter the submenu.

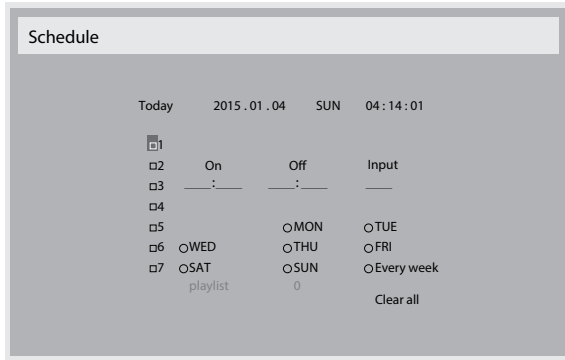

2. Press [▲] or [▼] button to select a schedule item (item number 1 ~ 7), and then press [OK] button to mark it the item number.

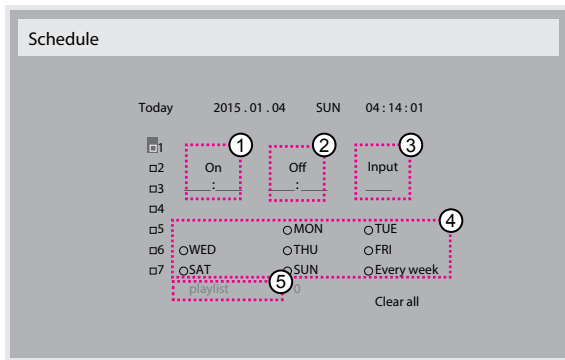

3. Press [←] or [→] button to select the schedule:
 - ① **Power-on** schedule: Press [▲] or [▼] button to set the hour and minute for the display to turn on.
 - ② **Power-off** schedule: Press [▲] or [▼] button to set the hour and minute for the display to turn off.

Select or leave an empty "___" for both the hour and minute slot if you do not want to use this power-on or power-off schedule.

 - ③ **Input-source** selection: Press [▲] or [▼] button to select an input source. If no input source is selected, the input source will remain the same as last selected.
 - ④ **Date** schedule: Press [←] button to select which day in a week this schedule item will be take effect, and then press the [OK] button.
 - ⑤ When **Input-source** select to **USB**, enable to access **playlist** setting:
4. For additional schedule settings, press [↵], then repeat the steps above. A check mark in the box next to the number of the schedule item indicates that the selected schedule is in effect.

NOTES:

- If the schedules overlap, the scheduled power-on time takes priority over scheduled power-off time.
- If there are two schedule items programmed for the same time, the highest numbered schedule takes priority. For example, if schedule items #1 and #2 both set the display to power on at 7:00 AM and off at 5:00 PM, then only schedule item # 2 will take effect.

HDMI with One Wire

CEC control.

- {Off} - Disable CEC.(Default)

- {On} - Enable CEC.

Auto signal detection

Choose to let the display detect and display available signal sources automatically.

- {Off} - Once a signal is connected, it can only be selected manually.

If the selected input is no signal, set the display to display the image automatically according to the search order of each option.

The options are: {All} / {Failover}

- {All}: DP -> HDMI1 -> HDMI2 -> DVI -> VGA ->Media Player -> Browser -> SmartCMS -> PDF Reader -> Custom.
- {Failover}
 - Failover 1: User-defined setting. Default:HDMI 1.
 - Failover 2: User-defined setting. Default:HDMI 1.
 - Failover 3: User-defined setting. Default:HDMI 1.
 - Failover 4: User-defined setting. Default:HDMI 1.
 - Failover 5: User-defined setting. Default:HDMI 1.
 - Failover 6: User-defined setting. Default:HDMI 1.
 - Failover 7: User-defined setting. Default:HDMI 1.
 - Failover 8: User-defined setting. Default:HDMI 1.
 - Failover 9: User-defined setting. Default:HDMI 1.
 - Failover 10: User-defined setting. Default:HDMI 1.

Power Save

Power save modes

Mode 1: DC off -> Power off. LED: Red.

Power Save -> Power off, LED: Red

Mode 2: DC off -> Power off, LED: Red.

Power Save -> Power Saving. LED: Orange. Can be wake up.

Mode 3: DC off -> Back light off, LED: Red

Power Save -> Back light off, LED: Orange. Can be wake up.

Mode 4: DC off -> Back light off, LED: Red

Power Save -> Will not enter power save mode. show "no signal" only.

*Note:When Auto FW update is not OFF, display will work under Mode3 for FW update, but OSD item will not change.

<u>Mode 3</u> DC OFF: Backlight Off only Power Save: Backlight Off only	<u>Mode 1(default)</u> DC OFF: Power Off Power Save: Power Off
<u>Mode 4</u> DC OFF: Backlight Off only Power Save: No signal(Backlight On)	<u>Mode 2</u> DC OFF: Power Off Power Save: Power Saving

Following table is the action for Android board with different power mode.

DC off/on: Press power button by RC

Power mode in OSD	Mode 1/2	Mode 3/4
DC off	shutdown	1. The current source APK(such as MediaPlayer, Browser, PDF, SmartCMS or Custom) will be closed.
2. Android system will go to the default black launcher.		
DC on	Boot up	1. Android system reboots

Scalar FW Update

Update scalar FW by USB.

Auto FW Update

Setup Android FW auto background update time.

* Note: When Auto FW update is not OFF, display will work under Mode3 for FW update, but OSD item will not change.

USB cloning

Copy PD settings from one set to another.

Import: Copy settings from file to display

Export: Copy PD settings into file.

* Cloned data stores in android internal storage. User need to use APK to copy cloned data to another display.

Advanced option reset

Reset all settings except {Date and Time} in the **Advanced option** menu to factory preset values.

1. Press [OK] or [→] button to enter the submenu.
2. Press [←] or [→] button to select {Reset} and press the [OK] button to restore settings to factory preset values.
3. Press the [↩] button or select {Cancel} and press the [OK] button to cancel and then return to the previous menu.

7. USB device compatibility

USB Multimedia Codec Formats

Video Decode						
Type	Video Codec	Container	Decode	Encode	Channel	Remark
MPEG1/2	MPEG1/2	File Format: DAT, MPG, VOB, TS	V			Supported Image Size: 48x48pixels to 1920x1088pixels Maximum Frame Rate: 30fps Maximum Bit Rate: 80Mbps Audio Codec: MP2, MP3
MPEG-4	MPEG4	File Format: AVI, MKV, MP4, MOV, 3GP	V			Supported Image Size: 48x48pixels to 1920x1088pixels Maximum Frame Rate: 30fps Maximum Bit Rate: 38.4Mbps Audio Codec: MP2, MP3, AAC, PCM, (1) Not support MS MPEG4 v1/v2/v3 (2) Not support GMC(global motion compensation)
H.263	H.263	File Format: 3GP, MOV, MP4	V			Supported Image Size: SQCIF(128x96), QCIF(176x144), CIF(352x288), 4CIF(704x576) Maximum Frame Rate: 30fps Maximum Bit Rate: 38.4Mbps Audio Codec: MP3 (1) Not support H.263+
H.264	H.264	File Format: AVI, MKV, MP4, MOV, 3GPTS, FLV	V			Supported Image Size: 48x48pixels to 1920x1088pixels Maximum Frame Rate: 30fps Maximum Bit Rate: 57.2Mbps Audio Codec: MP2, MP3, AAC, PCM (1) Not support MBAFF
GOOGLE VP8	VP8	File Format: WEBM	V			Supported Image Size: 48x48pixels to 1920x1088pixels Maximum Frame Rate: 30fps Maximum Bit Rate: 38.4Mbps Audio Codec: Ogg Vorbis
VC-1	VC1	File Format: ASF, TS, MKV, AVI	V			Supported Image Size: 48x48pixels to 1920x1088pixels Maximum Frame Rate: 30fps Maximum Bit Rate: 45Mbps Audio Codec: MP2, MP3, AAC, WMA
Motion JPEG	MJPEG	File Format: AVI, MOV	V			Supported Image Size: 48x48pixels to 1920x1088pixels Maximum Frame Rate: 30fps Maximum Bit Rate: 38.4Mbps Audio Codec: MP2, MP3, AAC, PCM

Audio Decode

Type	Audio Codec	Container	Decode	Encode	Channel	Remark
MPEG Audio	MPEG1/2/2.5 Audio Layer1/2/3	Decode: MP1, MP2, MP3	V		2	Bit Rate: 8kbps~320Kbps, CBR and VBR Sampling Rate: 8KHZ~48KHz
Windows Media Audio	WMA Version 4,4.1, 7, 8, 9, wmapro	Decode: WMA	V		2	Bit Rate: 8kbps~320Kbps Sampling Rate: 8KHZ~48KHz Non-support WMA Pro, lossless and MBR
AAC Audio	MAIN, ADIF, ATDS Header AAC-LC and AAC-HE	File Format: AAC, M4A	V		5.1	Bit Rate: N/A Sampling Rate: 8KHZ~48KHz

Image Decode

Type	Image Codec	Photo	Decode	Encode	Channel	Remark
JPEG	JFIF file format 1.02	File Format: JPG, JPEG	√			Decode: Resolution 48X48 to 8176X8176 (1) Not Support Non-interleaved Scan (2) Software support SRGB JPEG (3) Software support Adobe RGB JPEG
BMP	BMP	File Format: BMP	√			MaximumSupported Image Size:4096x4096 pixels
GIF	GIF	File Format: GIF	√			Resolution No Restriction
PNG	PNG	File Format: PNG	√			Resolution No Restriction

NOTES:

- Sound or video may not work if the contents have a standard bit rate/frame rate above the compatible Frame/sec listed in the table above.
- Video content with a Bit rate or Frame rate larger than the rate specified in the table above can cause choppy video during playback.

8. Input Mode

VGA Resolution:

Standard Resolution	Active Resolution		Refresh Rate	Pixel Rate	Aspect Ratio	Stand for Mode
	H Pixels	V Lines				
VGA	640	480	60 Hz	25.175 MHz	4:3	Video Graphic Array
			72 Hz	31.5 MHz		
			75 Hz	31.5 MHz		
WVGA	720	400	70 Hz	33.75 MHz	16:9	Wide Video Graphic Array
SVGA	800	600	60 Hz	40 MHz	4:3	Super VGA
			75 Hz	49.5 MHz		
XGA	1024	768	60 Hz	65 MHz	4:3	Extended Graphic Array
			75 Hz	78.75 MHz		
WXGA	1280	768	60 Hz	79.5 MHz	5:3	Wide XGA
WXGA	1280	800	60 Hz	79.5 MHz	16:10	Wide XGA
SXGA	1280	1024	60 Hz	108 MHz	5:4	Super XGA
WXGA	1360	768	60 Hz	85.5 MHz	16:9	Wide XGA
UXGA	1600	1200	60 Hz	162 MHz	4:3	Ultra XGA
HD1080	1920	1080	60 Hz	148.5 MHz	16:9	HD1080

SDTV Resolution:

Standard Resolution	Active Resolution		Refresh Rate	Pixel Rate	Aspect Ratio	Stand for Mode
	H Pixels	V Lines				
480i	720	480	59.94 Hz	27 MHz	4:3	Modified NTSC Standard
480p						
576i	720	576	50 Hz	27 MHz	4:3	Modified PAL Standard
576p						

HDTV Resolution:

Standard Resolution	Active Resolution		Refresh Rate	Pixel Rate	Aspect Ratio	Stand for Mode
	H Pixels	V Lines				
720p	1280	720	50 Hz	74.25 MHz	16:9	Normally DVB Mode
			60 Hz			
1080i	1920	1080	50 Hz	74.25 MHz	16:9	Normally ATSC Mode
			60 Hz	74.176 MHz		
1080p	1920	1080	50 Hz	148.5 MHz	16:9	Normally ATSC Mode
			60 Hz	148.325 MHz		

- The PC text quality is optimum in HD 1080 mode (1920 x 1080, 60Hz).
- Your PC display screen might appear different depending on the manufacturer (and your particular version of Windows).
- Check your PC instruction book for information about connecting your PC to a display.
- If a vertical and horizontal frequency-select mode exists, select 60Hz (vertical) and 31.5KHz (horizontal). In some cases, abnormal signals (such as stripes) might appear on the screen when the PC power is turned off (or if the PC is disconnected). If so, press the [INPUT] button to enter the video mode. Also, make sure that the PC is connected.
- When horizontal synchronous signals seem irregular in RGB mode, check PC power saving mode or cable connections.
- The display settings table complies to the IBM/VESA standards, and based on the analog input.
- The DVI support mode is regarded as same to the PC support mode.
- The best timing for the vertical frequency to each mode is 60Hz.

9. Pixel Defect Policy

We strive to deliver the highest quality products and use some of the industry's most advanced manufacturing processes whilst practicing stringent quality control. However, pixel or sub-pixel defects on the PDP / TFT panels used in Plasma- & LCD- displays are sometimes unavoidable. No manufacturer can guarantee that all panels will be free from pixel defects, but Philips guarantees that any Plasma- & LCD- displays with an unacceptable number of defects will be repaired during the warranty period in line with your local guarantee conditions.

This notice explains the different types of pixel defects and defines the acceptable defect level for the LCD screen. In order to qualify for repair under warranty, the number of pixel defects must exceed a certain level as shown in the reference table. If the LCD screen is within specification a warranty exchange / claim back will be refused. Additionally, because some types or combinations of pixel defects are more noticeable than others, Philips sets even higher quality standards for those.

9.1. Pixels and Sub-Pixels

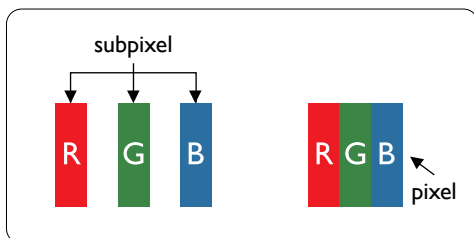

A pixel, or picture element, is composed of three sub-pixels in the primary colors of red, green and blue. Many pixels together form an image. When all sub-pixels of a pixel are lit, the three colored sub-pixels together appear as a single white pixel. When all are dark, the three colored sub-pixels together appear as a single black pixel. Other combinations of lit and dark sub-pixels appear as single pixels of other colors.

9.2. Types of Pixel Defects + Dot Definition

Pixel and sub-pixel defects appear on the screen in different ways. There are three categories of pixel defects and several types of sub-pixel defects within each category.

Dot definition = What is a defective "Dot"?

One or more defective, adjacent sub-pixel are defined as one "dot". The no. of defective sub-pixels are not relevant to define a defective dot. This means that a defective dot can consist of one, two or three defective sub-pixels which can be dark or lit.

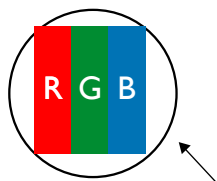

One dot = One Pixel; consists of three sub-pixels of Red, Green, and Blue.

9.3. Bright Dot Defects

Bright dot defects appear as pixels or sub-pixels that are always lit or "on". These are the examples of bright dot defects:

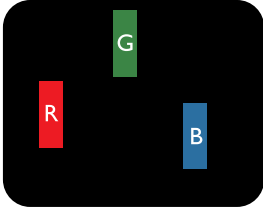
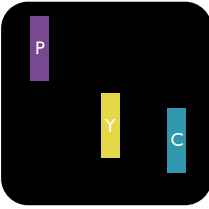
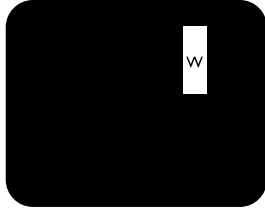
 <p>One lit red, green or blue sub pixel</p>	 <p>Two adjacent lit sub pixels: Red + Blue = Purple Red + Green = Yellow Green + Blue = Cyan (Light Blue)</p>	 <p>Three adjacent lit sub pixels (one white pixel)</p>
---	--	--

9.4. Dark Dot Defects

Black dot defects appear as pixels or sub-pixels that are always dark or "off". These are the examples of black dot defects:

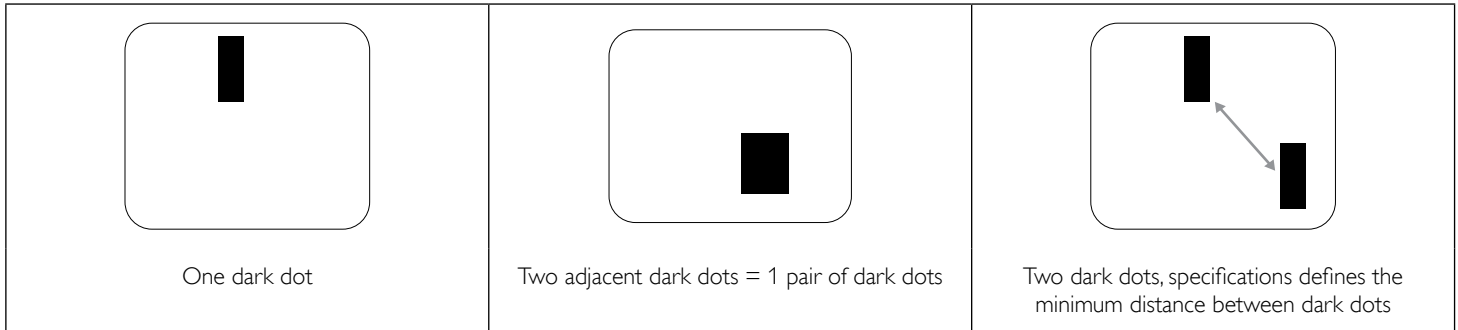

9.5. Proximity of Pixel Defects

Because pixel and sub-pixels defects of the same type that are nearby one another may be more noticeable, Philips also specifies tolerances for the proximity of pixel defects. In the table below you can find specifications about:

- Allowed amount of adjacent dark dots = (adjacent dark dots = 1 pair of dark dots)
- Minimum distance between dark dots
- Total no. of all defective dots

9.6. Pixel Defect Tolerances

In order to qualify for repair due to pixel defects during the warranty period, a PDP / TFT panel in a Philips Plasma / LCD- display must have pixel or sub-pixel defects exceeding the tolerances listed in the following table.

BRIGHT DOT EFFECT	ACCEPTABLE LEVEL
1 lit sub pixel	2
BLACK DOT EFFECT	ACCEPTABLE LEVEL
1 dark sub pixel	10
TOTAL DOT DEFECTS OF ALL TYPES	12

NOTE: * 1 or 2 adjacent sub pixel defects = 1 dot defect

9.7. MURA

Dark spots or patches may occasionally appear on some liquid crystal display (LCD) panels. This is known within the industry as Mura, which is a Japanese term for "unevenness." It is used to describe an irregular pattern or area in which uneven screen uniformity appears under certain conditions. Mura is a result of the deterioration of the liquid crystal alignment layer and is most commonly caused by long-term operation under high ambient temperatures. It is an industry- wide phenomenon and Mura is not repairable. It is also not covered by our warranty terms.

Mura has been around since the introduction of LCD technology and with screens getting bigger and in operation 24/7, many displays are running in low light conditions. This all adds to the possibility of Mura affecting displays.

HOW TO SPOT MURA

There are many symptoms of Mura and also multiple causes. Several of these are listed below:

- Impurities or foreign particles in the crystal matrix
- Uneven distribution of LCD matrix during manufacturing
- Non-uniform luminance distribution of the backlight
- Panel assembly induced stress
- Flaws within the LCD cells
- Thermal induced stress - high temperature operation over long periods of time

HOW TO AVOID MURA

Although we can not guarantee the complete eradication of Mura every time, in general the appearance of Mura can be minimized by these methods:

- Lower the backlight brightness
- Use a screen saver
- Reduce the ambient temperature around the unit

10. Cleaning and Troubleshooting

10.1. Cleaning

Caution When Using the Display

- Do not bring your hands, face or objects close to the ventilation holes of the display. The top of the display is usually very hot due to the high temperature of exhaust air being released through the ventilation holes. Burns or personal injuries may occur if any body parts are brought too close. Placing any object near the top of the display could also result in heat related damage to the object as well as the display itself.
- Be sure to disconnect all cables before moving the display. Moving the display with its cables attached may damage the cables and thus cause fire or electric shock.
- Disconnect the power plug from the wall outlet as a safety precaution before carrying out any type of cleaning or maintenance procedure.

Front Panel Cleaning Instructions

- The front of the display has been specially treated. Wipe the surface gently using only a cleaning cloth or a soft, lint-free cloth.
- If the surface becomes dirty, soak a soft, lint-free cloth in a mild detergent solution. Wring the cloth to remove excess liquid. Wipe the surface of the display to remove dirt. Then use a dry cloth of the same type to dry.
- Do not scratch or hit the surface of the panel with fingers or hard objects of any kind.
- Do not use volatile substances such as insect sprays, solvents and thinners.

Cabinet Cleaning Instructions

- If the cabinet becomes dirty, wipe the cabinet with a soft, dry cloth.
- If the cabinet is extremely dirty, soak a lint-free cloth in a mild detergent solution. Wring the cloth to remove as much moisture as possible. Wipe the cabinet. Use another dry cloth to wipe over until the surface is dry.
- Do not allow any water or detergent to come into contact with the surface of the display. If water or moisture gets inside the unit, operating problems, electrical and shock hazards may result.
- Do not scratch or hit the cabinet with fingers or hard objects of any kind.
- Do not use volatile substances such as insect sprays, solvents and thinners on the cabinet.
- Do not place anything made from rubber or PVC near the cabinet for any extended periods of time.

10.2. Troubleshooting

Symptom	Possible Cause	Remedy
No picture is displayed	<ol style="list-style-type: none"> 1. The power cord is disconnected. 2. The main power switch on the back of the display is not switched on. 3. The selected input has no connection. 4. The display is in standby mode. 	<ol style="list-style-type: none"> 1. Plug in the power cord. 2. Make sure the power switch is switched on. 3. Connect a signal connection to the display.
Interference displayed on the display or audible noise is heard	Caused by surrounding electrical appliances or fluorescent lights.	Move the display to another location to see if the interference is reduced.
Color is abnormal	The signal cable is not connected properly.	Make sure that the signal cable is attached firmly to the back of the display.
Picture is distorted with abnormal patterns	<ol style="list-style-type: none"> 1. The signal cable is not connected properly. 2. The input signal is beyond the capabilities of the display. 	<ol style="list-style-type: none"> 1. Make sure that the signal cable is attached firmly. 2. Check the video signal source to see if it is beyond the range of the display. Please verify its specifications with this display's specification section.
Display image doesn't fill up the full size of the screen	<ol style="list-style-type: none"> 1. The zoom mode is not set correctly. 2. Scan Mode may be set incorrectly to underscan. 3. If the image exceeds the screen size, Scan Mode may need to be set to Underscan. 	Use the Zoom mode or Custom zoom function in the Screen menu to fine tune display geometry and time frequency parameter.
Can hear sound, but no picture	Improperly connected source signal cable.	Make sure that both video inputs and sound inputs are correctly connected.
Can see picture but no sound is heard	<ol style="list-style-type: none"> 1. Improperly connected source signal cable. 2. Volume is turned all the way down. 3. {Mute} is turned on. 4. No external speaker connected. 	<ol style="list-style-type: none"> 1. Make sure that both video inputs and sound inputs are correctly connected. 2. Press [+] or [-] button to hear sound. 3. Switch MUTE off by using the [MUTE] button. 4. Connect external speakers and adjust the volume to a suitable level.
Some picture elements do not light up	Some pixels of the display may not turn on.	This display is manufactured using an extremely high level of precision technology; however, sometimes some pixels of the display may not display. This is not a malfunction.
After-Images can still be seen on the display after the display is powered off. (Examples of still pictures include logos, video games, computer images, and images displayed in 4:3 normal mode)	A still picture is displayed for an over extended period of time	Do not allow a still image to be displayed for an extended period of time as this can cause a permanent after-image to remain on the display.

11. Technical Specifications

Display:

Item	Specifications
Screen Size (Active Area)	54.64 Inches (1387.80 mm) diagonal LCD
Aspect Ratio	16:9
Number of pixels	1920 (H) × 1080 (V)
Pixel pitch	0.630 (H) × 0.630 (V) [mm]
Displayable colors	8bits(D),16.7 Million colors
Brightness (typical)	450 cd/m ² (typ)
Contrast ratio (typical)	1100:1
Viewing angle	178 degrees

In/Out Terminals:

Item	Specifications
Speaker Output	Internal Speakers 10W (L) + 10W (R) [RMS]/8Ω 1 Way 1 Speaker System 82 dB / W / M / 160 Hz ~ 13 KHz
Audio Output	Phone Jack × 1 0.5V [rms] (Normal) / 2 Channel (L+R)
Audio Input	3.5 mm Stereo × 1 0.5V [rms] (Normal) / 2 Channel (L+R)
RS232	2.5mm Phone jack × 2 RS232 in / RS232 out
RJ-45	RJ-45 Jack × 1 (8 pin) 10/100 LAN Port
HDMI Input	HDMI Jack × 2 (Type A) (19 pin) Digital RGB: TMDS (Video + Audio) MAX: Video - 720p, 1080p, 1920 × 1080/60 Hz (WUXGA) Audio - 48 KHz / 2 Channel (L+R) Supports LPCM only
DVI-I(DVI-D & VGA) Input	DVI-I jack Digital RGB: TMDS (Video) Analog RGB: 0.7V [p-p] (75Ω), H/CSV: TTL (2.2kΩ), SOG: 1V [p-p] (75Ω) MAX: 720p, 1080p, 1920 × 1080/60 Hz (WUXGA)
DVI-I (DVI-D & VGA) Output	DVI-I Jack × 1 (29 pin) Digital RGB: TMDS (Video) Analog RGB: 0.7V [p-p] (75Ω), H/CSV: TTL (2.2kΩ), SOG: 1V [p-p] (75Ω) MAX: 720p, 1080p, 1920 × 1080/60 Hz (WUXGA)
Displayport in/out	Displayport Jack × 2 (20 pin) Digital RGB: TMDS (Video + Audio) MAX: Video - 720p, 1080p, 1920 × 1080/60 Hz (WUXGA) Audio - 48 KHz / 2 Channel (L+R) Supports LPCM only

Item	Product Fiche
Energy Efficiency Class	A+
Visible Screen Size	1387.80 cm / 54.64 inch
On Mode Power Consumption (W)	77 W
Annual Energy Consumption (kWh)	112 kWh
Standby Power Consumption (W)	0.50 W
Off Mode Power Consumption (W)	0.50 W
Display Resolution (Pixels)	1920 × 1080p
Network Standby (W)	3 W

General:

Item	Specifications
Internal memory	16GB eMMC (12GB usable)
Power Supply	AC 100 - 240V, 50 - 60Hz
Power Consumption (Max)	139 W
Power Consumption (typ.)	76 W
Power Consumption (Standby & Off)	<0.5W (RS232 in active)
Dimensions (Without Stand) [W x H x D]	1233.4 x 710.3 x 45.5 mm
Weight (Without Stand)	18.0 Kg
Gross Weight (Without Stand)	24.4 Kg

Environmental Condition:

Item	Specifications	
Temperature	Operational	0 ~ 40°C
	Storage	-20 ~ 60°C
Humidity	Operational	20 ~ 80% RH (No condensation)
	Storage	5 ~ 95% RH (No condensation)
Altitude	Operational	0 ~ 3,000 m
	Storage / Shipment	0 ~ 9,000 m

Internal Speaker:

Item	Specifications
Type	1 Way 1 Speaker
Input	10 W (RMS)
Impedance	8Ω
Output Sound Pressure	82 dB/W/M
Frequency Response	160 Hz ~ 13 KHz



2016 © Koninklijke Philips N.V. All rights reserved.

Philips and the Philips Shield Emblem are registered trademarks of Koninklijke Philips N.V. and are used under license from Koninklijke Philips N.V.

Specifications are subject to change without notice.